



E-Drive™

User Manual

version 4-3



Contents

Section 1 - Introduction	1-1
1.1 Intended Use	1-1
1.2 Release Details	1-1
1.3 Warranty	1-1
1.4 Returned Goods Policy.....	1-1
1.5 Movement or Resale of Mold-Masters Products or Systems	1-1
1.6 Copyright	1-2
1.7 Units of Measure and Conversion Factors	1-2
 Section 2 - Global Support	 2-1
2.1 Corporate Offices.....	2-1
2.2 International Representatives.....	2-2
 Section 3 - Safety.....	 3-1
3.1 Introduction.....	3-1
3.2 Safety Hazards	3-2
3.3 Operational Hazards.....	3-5
3.4 General Safety Symbols.....	3-7
3.5 Wiring Check	3-8
3.6 Lockout Safety	3-9
3.7 Electrical Lockout	3-10
3.7.1 Energy Forms and Lockout Guidelines.....	3-11
3.8 Disposal.....	3-12
3.9 E-Drive Safety Hazards	3-13
3.9.1 Operational Environment.....	3-13
3.10 Ground Connections.....	3-14
 Section 4 - E-Drive.....	 4-1
4.1 Typical System.....	4-1
4.2 Components	4-3
4.3 Safety	4-4
4.4 Assembly	4-5
4.5 Attaching a Hot Runner Assembly	4-6
4.6 Attaching an Interface Plate Assembly	4-6
4.7 Assembling a Synchro-Plate.....	4-7
4.8 Preparing a Ball Screw	4-8
4.9 Lubricating a Ball Screw	4-8
4.10 Assembling a Ball Screw	4-9
4.11 Assembling a Top Plate.....	4-10
4.12 Attaching a Synchro-Plate to a Top Plate Assembly	4-10
4.13 Assembling a Tension Belt.....	4-10
4.14 Assembling an Insulation Plate and a Locating Ring.....	4-12
4.15 Doing E-Drive Controller Checks.....	4-13
4.16 Installing a Hot Half in a Mold.....	4-13
4.17 Installing or Replacing a Belt	4-13
4.18 Doing a Check for Misalignment.....	4-15

Section 5 - Mag-Pin Option.....	5-1
5.1 Assembly	5-2
5.2 Safety	5-2
5.3 Operation.....	5-3
5.3.1 Handling Magnets.....	5-5
5.3.2 Summary of the Assembly Procedure	5-6
5.3.3 Assembling	5-6
Section 6 - Maintenance.....	6-1
6.1 Ball Screws.....	6-1
Section 7 - Controller Overview	7-1
7.1 System Overview.....	7-2
7.2 Touchscreen Buttons	7-2
7.3 Configuration	7-2
7.4 E-Drive Actuator Models.....	7-2
7.5 Controller Front.....	7-3
7.6 Controller Connections	7-4
7.7 Main Screen	7-5
7.7.1 Top Menu Buttons.....	7-5
7.7.2 Side Menu Buttons	7-6
7.7.3 Bottom Information Bar.....	7-7
Section 8 - Controller Operation	8-1
8.1 Powering the Controller	8-1
8.2 User Access.....	8-1
8.3 Logging-in.....	8-1
8.4 Creating a New Project.....	8-4
8.5 Setting the System Limits	8-6
8.5.1 Setting the Jog Velocity	8-7
8.5.2 Setting the Jog Ramp	8-8
8.5.3 Setting the Jog/Home Torque	8-9
8.6 Enabling the Servo Motors	8-11
8.7 Homing the System	8-12
8.7.1 Setting a Profile	8-14
8.8 Viewing Drive Information.....	8-18
8.9 Triggers.....	8-19
8.9.1 Setting a Digital Trigger	8-20
8.9.2 Monitoring Digital Triggers.....	8-21
8.9.3 Calibrating Analog Inputs.....	8-23
8.9.4 Setting Analog Triggers.....	8-25
Section 9 - Troubleshooting	9-1
9.1 Alarm Messages	9-1
Section 10 - Wiring Details	10-1
10.1 Three-Phase Supply Cable and Miniature Circuit Breaker (MCB)	10-1
10.2 Auxilliary Input	10-2

10.3 Machine Interface (HA16).....	10-2
10.4 HMI Connection.....	10-3
10.5 Servo Connections	10-4

Section 1 - Introduction

The purpose of this manual is to assist users in the integration, operation and maintenance of the E-Drive. This manual is designed to cover most system configurations. If you need additional information specific to your system, please contact your representative or a Mold-Masters office whose location can be found in the “Global Support” section.

1.1 Intended Use

The E-Drive is a servo electrical gate controller, which is designed to be safe during normal operation. Any other uses would fall outside the engineered intent of this machine and may result in safety hazards. Use of this unit outside of its intended scope will void any and all warranties.

This manual is written to be used by skilled persons who are familiar with hot runner controllers and their terminology. Operators should be familiar with plastic injection molding machines and the controls of such equipment. Maintenance persons should have sufficient understanding of electrical safety to appreciate the dangers of 3-phase supplies. They should know how to take appropriate measures to avoid any danger from electrical supplies.

1.2 Release Details

When ordering this manual, please reference the document number below.

Table 1-1 Release Details		
Document Number	Release Date	Version
UM--EDR--ENG--4-2	August 2023	04-2
UM--EDR--ENG--4-3	January 2025	04-3

1.3 Warranty

For current warranty information please refer to the documents available from our website www.moldmasters.com/support/warranty or contact your *Mold-Masters* representative.

1.4 Returned Goods Policy

Please do not return any parts to *Mold-Masters* without pre-authorization and a return authorization number supplied by *Mold-Masters*.

Our policy is one of continuous improvement and we reserve the right to alter product specifications at any time without giving notice.

1.5 Movement or Resale of Mold-Masters Products or Systems

This documentation is intended for use in the country of destination for which the product or system was purchased.

Mold-Masters takes no responsibility for documentation of products or systems if they are relocated or resold outside the intended country of destination, as stated on the accompanying invoice and/or waybill.

1.6 Copyright

© 2025 Mold-Masters (2007) Limited. All Rights Reserved. *Mold-Masters®* and the *Mold-Masters* logo are trademarks of Mold-Masters.

1.7 Units of Measure and Conversion Factors



NOTE

The dimensions given in this manual are from original manufacturing drawings.

All values in this manual are in S.I. units or subdivisions of these units. Imperial units are given in parenthesis immediately after the S.I. units.

Table 1-2 Units of Measure and Conversion Factors		
Abbreviation	Unit	Conversion Value
bar	Bar	14.5 psi
in.	Inch	25.4 mm
kg	Kilogram	2.205 lb
kPa	Kilopascal	0.145 psi
gal	Gallon	3.785 l
lb	Pound	0.4536 kg
lbf	Pound force	4.448 N
lbf.in.	Pound force inch	0.113 Nm
l	Litre	0.264 gallon
min	Minute	
mm	Millimeter	0.03937 in.
mΩ	Milli Ohm	
N	Newton	0.2248 lbf
Nm	Newton Meter	8.851 lbf.in.
psi	Pound per square inch	0.069 bar
psi	Pound per square inch	6.895 kPa
rpm	Revolutions per minute	
s	Second	
°	Degree	
°C	Degree Celsius	0.556 (°F -32)
°F	Degree Fahrenheit	1.8 °C +32

Section 2 - Global Support

2.1 Corporate Offices

GLOBAL HEADQUARTERS

CANADA

Mold-Masters (2007) Limited
233 Armstrong Avenue
Georgetown, Ontario
Canada L7G 4X5
tel: +1 905 877 0185
fax: +1 905 877 6979
canada@moldmasters.com

SOUTH AMERICAN HEADQUARTERS

BRAZIL

Mold-Masters do Brasil Ltda.
R. James Clerk Maxwell,
280 – Techno Park, Campinas
São Paulo, Brazil, 13069-380
tel: +55 19 3518 4040
brazil@moldmasters.com

UNITED KINGDOM & IRELAND

Mold-Masters (UK) Ltd Netherwood
Road
Rotherwas Ind. Est.
Hereford, HR2 6JU
United Kingdom
tel: +44 1432 265768
fax: +44 1432 263782
uk@moldmasters.com

AUSTRIA / EAST & SOUTHEAST EUROPE

Mold-Masters Handelsges.m.b.H.
Pyhrnstrasse 16
A-4553 Schlierbach
Austria
tel: +43 7582 51877
fax: +43 7582 51877 18
austria@moldmasters.com

ITALY

Mold-Masters Italia
Via Germania, 23
35010 Vigonza (PD)
Italy
tel: +39 049/5019955
fax: +39 049/5019951
italy@moldmasters.com

EUROPEAN HEADQUARTERS

GERMANY / SWITZERLAND

Mold-Masters Europa GmbH
Neumatttring 1
76532 Baden-Baden, Germany
tel: +49 7221 50990
fax: +49 7221 53093
germany@moldmasters.com

INDIAN HEADQUARTERS

INDIA

Milacron India PVT Ltd. (Mold-
Masters Div.)
3B, Gandhiji Salai,
Nallampalayam, Rathinapuri
Post, Coimbatore T.N. 641027
tel: +91 422 423 4888
fax: +91 422 423 4800
india@moldmasters.com

USA

Mold-Masters Injectioneering
LLC, 29111 Stephenson
Highway, Madison Heights, MI
48071, USA
tel: +1 800 450 2270 (USA
only) tel: +1 (248) 544-5710
fax: +1 (248) 544-5712
usa@moldmasters.com

CZECH REPUBLIC

Mold-Masters Europa GmbH
Hlavni 823
75654 Zubri
Czech Republic
tel: +420 571 619 017
fax: +420 571 619 018
czech@moldmasters.com

KOREA

Mold-Masters Korea Ltd. E
dong, 2nd floor, 2625-6,
Jeongwang-dong, Siheung
City, Gyeonggi-do, 15117,
South Korea
tel: +82-31-431-4756
korea@moldmasters.com

ASIAN HEADQUARTERS

CHINA/HONG KONG/TAIWAN

Mold-Masters (KunShan) Co, Ltd
Zhao Tian Rd
Lu Jia Town, KunShan City
Jiang Su Province
People's Republic of China
tel: +86 512 86162882
fax: +86 512-86162883
china@moldmasters.com

JAPAN

Mold-Masters K.K.
1-4-17 Kurikidai, Asaoku Kawasaki,
Kanagawa
Japan, 215-0032
tel: +81 44 986 2101
fax: +81 44 986 3145
japan@moldmasters.com

FRANCE

Mold-Masters France
ZI la Marinière,
2 Rue Bernard Palissy
91070 Bondoufle, France
tel: +33 (0) 1 78 05 40 20
fax: +33 (0) 1 78 05 40 30
france@moldmasters.com

MEXICO

Milacron Mexico Plastics Services
S.A. de C.V.
Circuito El Marques norte #55
Parque Industrial El Marques
El Marques, Queretaro C.P. 76246
Mexico
tel: +52 442 713 5661 (sales)
tel: +52 442 713 5664 (service)
mexico@moldmasters.com

Corporate Offices - continued

SINGAPORE*

Mold-Masters Singapore PTE. Ltd.
No 48 Toh Guan Road East
#06-140 Enterprise Hub
Singapore 608586
Republic of Singapore
tel: +65 6261 7793
fax: +65 6261 8378
singapore@moldmasters.com
*Coverage includes Southeast
Asia, Australia, and New Zealand

SPAIN

Mold-Masters Europa GmbH
C/ Tecnología, 17
Edificio Canadá PL. 0 Office A2
08840 – Viladecans
Barcelona
tel: +34 93 575 41 29
e: spain@moldmasters.com

TURKEY

Mold-Masters Europa GmbH
Merkezi Almanya Türkiye
İstanbul Şubesi
Alanaldı Caddesi Bahçelerarası
Sokak No: 31/1
34736 İçerenköy-Ataşehir
İstanbul, Turkey
tel: +90 216 577 32 44
fax: +90 216 577 32 45
turkey@moldmasters.com

2.2 International Representatives

Argentina

Sollwert S.R.L.
La Pampa 2849 2] B
C1428EAY Buenos Aires
Argentina
tel: +54 11 4786 5978
fax: +54 11 4786 5978 Ext.
35 sollwert@fibertel.com.ar

Belarus

HP Promcomplect
Sharangovicha 13
220018 Minsk
tel: +375 29 683-48-99
fax: +375 17 397-05-65
e:info@mold.by

Bulgaria

Mold-Trade OOD
62, Aleksandrovska
St. Ruse City
Bulgaria
tel: +359 82 821 054
fax: +359 82 821 054
contact@mold-trade.com

Denmark*

Englmayer A/S
Dam Holme 14-16
DK – 3660 Stenløse
Denmark tel: +45 46 733847
fax: +45 46 733859
support@englmayer.dk
*Coverage includes Norway
and Sweden

Finland**

Oy Scalar Ltd.
Tehtaankatu
10 11120 Riihimäki
Finland
tel: +358 10 387 2955
fax: +358 10 387 2950
info@scalar.fi
**Coverage includes Estonia

Greece

Ionian Chemicals S.A.
21 Pentelis Ave.
15235 Vrilissia, Athens
Greece
tel: +30 210 6836918-9
fax: +30 210 6828881
m.pavlou@ionianchemicals.gr

Israel

ASAF Industries Ltd. 29 Habanai
Street
PO Box 5598 Holon 58154 Israel
tel: +972 3 5581290
fax: +972 3 5581293
sales@asaf.com

Portugal

Gecim LDA
Rua Fonte Dos Ingleses, No 2
Engenho
2430-130 Marinha Grande
Portugal
tel: +351 244 575600
fax: +351 244 575601
gecim@gecim.pt

Romania

Tehnic Mold Trade SRL
Str. W. A Mozart nr. 17 Sect. 2
020251 Bucharesti
Romania
tel: +4 021 230 60 51
fax : +4 021 231 05 86
contact@matritehightech.ro

Russia

System LLC
Prkt Marshala Zhukova 4
123308 Moscow
Russia
tel: +7 (495) 199-14-51
moldmasters@system.com.ru

Slovenia

RD PICTA tehnologije d.o.o.
Žolgarjeva ulica 2
2310 Slovenska Bistrica
Slovenija
+386 59 969 117
info@picta.si

Ukraine

Company Park LLC
Gaydamatska str., 3, office 116
Kemenskoe City Dnipropetrovsk
Region 51935, Ukraine
tel: +38 (038) 277-82-82
moldmasters@parkgroup.com.ua

Section 3 - Safety

3.1 Introduction

Please be aware that the safety information provided by *Mold-Masters* does not absolve the integrator and employer from understanding and following international and local standards for safety of machinery. It is the responsibility of the end integrator to integrate the final system, provide necessary e-stop connections, safety interlocks and guarding, to select the appropriate electrical cable for the region of use and to ensure compliance with all relevant standards.

It is the responsibility of the employer to:

- Properly train and instruct its personnel in the safe operation of equipment, including the use of all the safety devices.
- Provide its personnel with all necessary protective clothing, including such items as a face shield and heat resistant gloves.
- Ensure the original and continuing competence of personnel caring for, setting up, inspecting and maintaining injection molding equipment.
- Establish and follow a program of periodic and regular inspections of injection molding equipment to ensure it is in safe operating condition and proper adjustment.
- Ensure that no modifications, repairs or rebuild of portions are made to the equipment that reduces the level of safety existing at time of manufacture or remanufacture.

3.2 Safety Hazards



WARNING

Also refer to all machine manuals and local regulations and codes for safety information.

The following safety hazards are most commonly associated with injection molding equipment. See European Standard EN201 or American Standard ANSI/SPI B151.1.

Refer to the illustration of hazard areas below when reading the Safety Hazards Figure 3-1 on page 3-2.

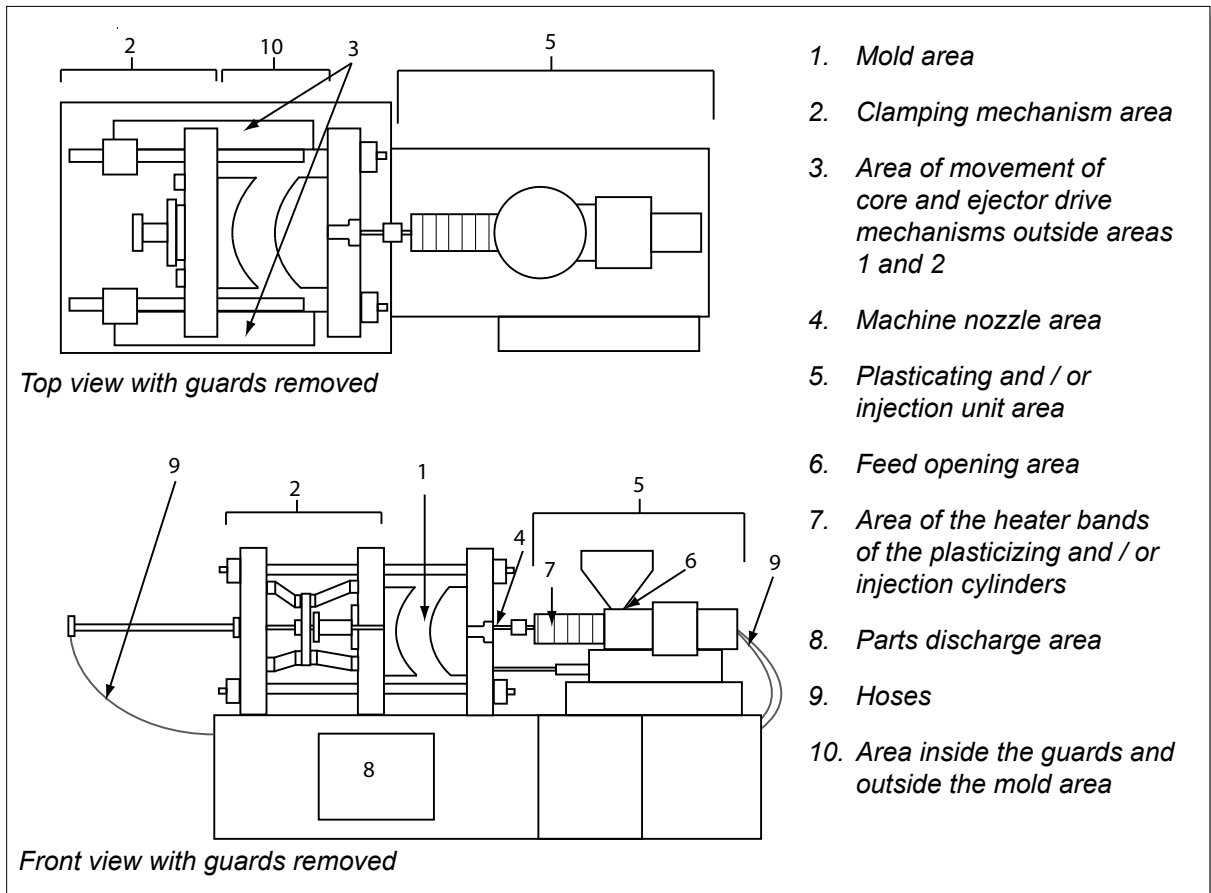

Figure 3-1 Injection molding machine hazard areas

Table 3-1 Safety Hazards	
Hazard Area	Potential Hazards
<p>Mold Area Area between the platens. See Figure 3-1 area 1</p>	<p>Mechanical Hazards Crushing and / or shearing and / or impact hazards caused by:</p> <ul style="list-style-type: none"> • Movement of the platen. • Movements of the injection barrel(s) into the mold area. • Movements of cores and ejectors and their drive mechanisms. • Tie bar motion. <p>Thermal Hazards Burns and / or scalds due to operating temperature of:</p> <ul style="list-style-type: none"> • The mold heating elements. • Material released from/through the mold.
<p>Clamping Mechanism Area See Figure 3-1 area 2</p>	<p>Mechanical Hazards Crushing and / or shearing and / or impact hazards caused by:</p> <ul style="list-style-type: none"> • Movement of the platen. • Movement of the drive mechanism of the platen. • Movement of the core and ejector drive mechanism.
<p>Movement of Drive Mechanisms Outside the Mold Area and Outside the Clamping Mechanism Area See Figure 3-1 area 3</p>	<p>Mechanical Hazards Mechanical hazards of crushing, shearing and / or impact caused by the movements of:</p> <ul style="list-style-type: none"> • Core and ejector drive mechanisms.
<p>Nozzle Area The nozzle area is the area between the barrel and the sprue bushing. See Figure 3-1 area 4</p>	<p>Mechanical Hazards Crushing, shearing hazards and / or impact hazards caused by:</p> <ul style="list-style-type: none"> • Forward movement of the plasticizing and / or injection unit including nozzle. • Movements of parts of the power-operated nozzle shutoff and their drives. • Over pressurization in the nozzle. <p>Thermal Hazards Burns and or scalds due to operating temperature of:</p> <ul style="list-style-type: none"> • The nozzle. • Material discharging from the nozzle.
<p>Plasticizing and / or Injection Unit Area Area from the adapter / barrel head / end cap to the extruder motor above the sled including the carriage cylinders. See Figure 3-1 area 5</p>	<p>Mechanical Hazards Crushing, shearing and / or drawn-into hazards caused by:</p> <ul style="list-style-type: none"> • Unintentional gravity movements e.g. for machines with plasticizing and / or injection unit positioned above the mold area. • The movements of the screw and / or the injection plunger in the cylinder accessible through the feed opening. • Movement of the carriage unit. <p>Thermal Hazards Burns and / or scalds due to operating temperature of:</p> <ul style="list-style-type: none"> • The plasticizing and / or injection unit. • The heating elements e.g. heater bands. • The material and / or vapors discharging from the vent opening, feed throat or hopper. <p>Mechanical and / or Thermal Hazard</p> <ul style="list-style-type: none"> • Hazards due to reduction in mechanical strength of the plasticizing and / or injection cylinder due to overheating.
<p>Feed Opening See Figure 3-1 area 6</p>	<p>Pinching and crushing between injection screw movement and housing.</p>

Table 3-1 Safety Hazards	
Hazard Area	Potential Hazards
Area of the Heater Bands of the Plasticizing and / or Injection Cylinders See Figure 3-1 area 7	Burns and / or scalds due to operating temperature of: <ul style="list-style-type: none"> • The plasticizing and / or injection unit. • The heating elements e.g. heater bands. • The material and / or vapors discharging from the vent opening, feed throat or hopper.
Parts Discharge Area See Figure 3-1 area 8	Mechanical Hazards Accessible Through the Discharge Area Crushing, shearing and / or impact hazards caused by: <ul style="list-style-type: none"> • Closing movement of the platen. • Movements of cores and ejectors and their drive mechanisms. Thermal Hazards Accessible through the discharge area Burns and or scalds due to operating temperature of: <ul style="list-style-type: none"> • The mold. • Heating elements of the mold. • Material released from / through the mold.
Hoses See Figure 3-1 area 9	<ul style="list-style-type: none"> • Whipping action caused by hose assembly failure. • Possible release of fluid under pressure that can cause injury. • Thermal hazards associated with hot fluid.
Area Inside the Guards and Outside the Mold Area See Figure 3-1 area 10	Crushing and / or shearing and / or impact hazards caused by: <ul style="list-style-type: none"> • Movement of the platen. • Movement of the drive mechanism of the platen. • Movement of the core and ejector drive mechanism. • Clamp opening movement.
Electrical Hazards	<ul style="list-style-type: none"> • Electrical or electromagnetic disturbance generated by the motor control unit. • Electrical or electromagnetic disturbance that can cause failures in the machine control systems and adjacent machine controls. • Electrical or electromagnetic disturbance generated by the motor control unit.
Hydraulic Accumulators	High pressure discharge.
Power Operated Gate	Crush or impact hazards caused by the movement of the power operated gates.
Vapors and Gases	Certain processing conditions and / or resins can cause hazardous fumes or vapors.

3.3 Operational Hazards



WARNINGS



- Refer to all machine manuals and local regulations and codes for safety information.
- The equipment supplied is subjected to high injection pressures and high temperatures. Ensure that extreme caution is observed in the operation and maintenance of the injection molding machines.
- Only fully trained personnel should operate or maintain equipment.
- Do not operate the equipment with unconfined long hair, loose clothing or jewelry, including name badges, neckties, etc. These may get caught in the equipment and can cause death or serious injury.
- Never disable or bypass a safety device.
- Ensure that the protective guards are placed around the nozzle to prevent the material from splashing or drooling.
- A burn hazard exists from material during routine purging. Wear heat-resistant personal protective equipment (PPE) to prevent burns from contact with hot surfaces or splatter of hot material and gases.
- Material purged from machine may be extremely hot. Ensure protective guards are in place around the nozzle to prevent material from splashing. Use proper personal protective equipment.
- All operators should wear personal protective equipment, such as face shields and use heat resistant gloves when working around the feed inlet, purging the machine or cleaning the gates of the mold.
- Remove purged material from the machine immediately.
- Decomposing or burning material could result in noxious gases being emitted from the purged material, feed inlet or mold.
- Ensure proper ventilation and exhaust systems are in place to help prevent inhalation of harmful gases and vapors.
- Consult manufacturer's Material Safety Data Sheets (MSDS).
- Hoses fitted to the mold will contain high or low temperature fluids or air under high pressure. The operator must shut down and lockout these systems as well as relieving any pressure before performing any work with these hoses. Regularly inspect and replace all flexible hoses and restraints.
- Water and / or hydraulics on the mold may be in close proximity to electrical connections and equipment. Water leakage may cause an electrical short circuit. Hydraulic fluid leakage may cause a fire hazard. Always keep water and / or hydraulic hoses and fittings in good condition to avoid leaks.
- Never perform any work on the mold machine unless the hydraulic pump has been stopped.
- Check frequently for possible oil leaks / water leaks. Stop the machine and make repairs.

**WARNING**

- Make sure that the cables are connected to the correct motors. Cables and motors are clearly labeled. Reversing the cables can result in unexpected and uncontrolled motion causing a safety risk or damage to the machine. A crushing hazard exists between the nozzle and mold melt inlet during carriage forward motion.
- A possible shearing hazard exists between the edge of the injection guard and the injection housing during injection.
- The open feed port could present a hazard to a finger or a hand inserted during operation of the machine.
- The electric servo motors could overheat presenting a hot surface which could cause burns to someone touching it.
- The barrel, barrel head, nozzle, heater bands and mold components are hot surfaces which could result in burns.
- Keep flammable liquids or dust away from the hot surfaces as they could ignite.
- Follow good housekeeping procedures and keep floors clean to prevent slips, trips and falls due to spilled material on the work floor.
- Apply engineering controls or hearing conservation programs as necessary to control noise.
- When doing any work on the machine that requires moving and lifting the machine, ensure that lifting equipment (eyebolts, fork lift truck, cranes, etc.) will have sufficient capacity to handle mold, auxiliary injection unit or Hot Runner weight.
- Connect all lifting devices and support the machine using a crane of adequate capacity before commencing work. Failure to support the machine can result in severe injury or death.
- Mold cable from the controller to the mold must be removed before servicing the mold.

3.4 General Safety Symbols

Table 3-2 Typical Safety Symbols	
Symbol	General Description
	General – Warning Indicates an immediate or potentially hazardous situation, which if not avoided, could result in a serious injury or death, and / or damage to equipment.
	Warning – Barrel Cover Grounding Strap Lockout / tagout procedures must be followed before removing the barrel cover. Barrel cover can become energized upon removal of grounding straps and contact can result in death or serious injury. Grounding straps must be reconnected before reconnecting power to machine.
	Warning – Crushing and / or Impact Points Contact with moving parts can cause serious crushing injury. Always keep guards in place.
	Warning – Crush Hazard Closing Mold
	Warning – Hazardous Voltage Contact with hazardous voltages will cause death or serious injury. Turn off power and review electrical schematics before servicing equipment. May contain more than one live circuit. Test all circuits before handling to make sure circuits have been de-energized.
	Warning – High Pressure Overheated fluids may cause severe burns. Discharge pressure before disconnecting water lines.
	Warning – High Pressure Accumulator Sudden release of high pressure gas or oil can cause death or serious injury. Discharge all gas and hydraulic pressure before disconnecting or disassembling accumulator.
	Warning – Hot Surfaces Contact with exposed hot surfaces will cause serious burn injury. Wear protective gloves when working near these areas.
	Mandatory – Lockout / Tagout Ensure that all energies are properly locked out, and remain locked out until the service work is completed. Servicing equipment without disabling all internal and external power sources can cause death or serious injury. De-energize all internal and external power sources (electrical, hydraulic, pneumatic, kinetic, potential, and thermal).
	Warning – Molten Material Splashing Hazard Molten material or high pressure gas can cause death or severe burns. Wear personal protective equipment while servicing the feed throat, nozzle, mold areas and when purging the injection unit.
	Warning – Read Manual Before Operation Personnel should read and understand all instructions in the manuals before working on equipment. Only properly trained personnel should operate the equipment.
	Warning – Slip, Trip or Fall Hazard Do not climb on equipment surfaces. Serious slip, trip, or fall injuries can result from personnel climbing on equipment surfaces.

Table 3-2 Typical Safety Symbols	
Symbol	General Description
	Caution Failure to follow instructions may damage equipment.
	Important Indicates additional information or used as a reminder.

3.5 Wiring Check



CAUTION

System Mains Supply Wiring:

- Before connecting the system to a power supply, it is important to check that the wiring between the system and the power supply has been done correctly.
- Particular attention must be given to the current rating of the power supply. For example, if a controller is rated at 63A, then the power supply must also be rated at 63A.
- Check that the phases of power supply are wired correctly.

Controller to Mold Wiring:

- For separate power and thermocouple connections, ensure that the power cables are never connected to the thermocouple connectors and vice-versa.
- For mixed power and thermocouple connections, ensure that the power and thermocouple connections have not been wired incorrectly.

Communications Interface and Control Sequence:

- It is the customer's responsibility to verify functionality of any custom machine interface at safe speeds, prior to operating equipment in the production environment at full speed in automatic mode.
- It is the customer's responsibility to verify all required motion sequences are correct, prior to operating equipment in the production environment at full speed in automatic mode.
- Switching the machinery into Auto mode without having verified the control interlocks and motion sequence are correct, may cause damage to machinery and / or equipment.

Failure to do wiring or connections properly will result in equipment failure.

The use of *Mold-Masters* standard connections can help to eliminate the potential for wiring errors.

Mold-Masters Ltd. cannot be responsible for damage caused by customer wiring and / or connection errors.

3.6 Lockout Safety



WARNING

DO NOT enter the cabinet without first ISOLATING the supplies.

High voltage and amperage cables are connected to the controller and the mold. Electrical power must be shut off and lockout / tagout procedures followed prior to installing or removing any cables.

Use lockout / tagout to prevent operation during maintenance.

All maintenance should be performed by properly trained personnel based on local laws and regulation. Electrical products may not be grounded when removed from the assembled or normal operating condition.

Ensure proper grounding of all electrical components before performing any maintenance to avoid potential risk of electrical shock.

Often power sources are inadvertently turned on or valves are opened mistakenly before maintenance work is completed, resulting in serious injuries and fatalities. Therefore, it is important to ensure that all energies are properly locked out and that they remain locked out until the work is completed.

If a lockout is not performed, uncontrolled energies could cause:

- Electrocution from contact with live circuits
- Cuts, bruises, crushing, amputations or death, resulting from entanglement with belts, chains, conveyors, rollers, shafts, impellers
- Burns from contact with hot parts, materials or equipment such as furnaces
- Fires and explosions
- Chemical exposures from gases or liquids released from pipelines

3.7 Electrical Lockout



WARNING - READ MANUAL

Refer to all machine manuals and local regulations and codes.



NOTE

In some instances, there may be more than one power source feeding equipment and steps must be taken to ensure that all sources are effectively locked out.

Employers must provide an effective lockout / tagout program.

1. Shut down machine using normal operational shutdown procedure and controls. This should be done by, or in consultation with the machine operator.
2. After ensuring that the machinery has been completely shut down, and all controls in the “off” position, open the main disconnect switch located in the field.
3. Using your own personal padlock, or one assigned by your supervisor, lock the disconnect switch in the off position. Do not lock only the box. Remove the key and retain. Complete a lockout tag and affix to the disconnect switch. Each person working on the equipment must follow this step. The lock of the person doing the work or in charge must be installed first, remain throughout and be removed last. Test the main disconnect switch and make sure it cannot be moved to the “on” position.
4. Try to start the machine using the normal operation controls and point of operation switches to make sure that the power has been disconnected.
5. Other sources of energy that could create a hazard while working on the equipment must also be de-energized and appropriately “locked-out”. This can include gravity, compressed air, hydraulics, steam and other pressurized or hazardous liquids and gases. See Table 3-3.
6. When the work is completed, prior to removing the last lock, make sure the operational controls are in the “off” position so that the main disconnect switching is done under “no load”. Ensure all blocks, tools and other foreign materials are removed from machine. Also ensure that all personnel that may be affected are informed that the lock(s) will be removed.
7. Remove lock and tag, and close the main disconnect switch if permission has been given.
8. When the work has not been completed on the first shift, the next operator should install a personal lock and tag before the first operator removes the original lock and tag. If the next operator is delayed, a lock and tag could be installed by the next supervisor. Lockout procedures should indicate how the transfer is to be conducted.
9. It is important that, for their personal protection, each worker and/or foreperson working in or on a machine places his/her own safety lock on the disconnect switch. Use tags to spotlight work in progress and give details of work being done. Only when the work is completed and the work permit signed off, may each worker remove his/her lock. The last lock to be removed should be that of the person supervising the lockout and this responsibility should not be delegated.

© Industrial Accident Prevention Association, 2008.

3.7.1 Energy Forms and Lockout Guidelines

Table 3-3 Energy Forms, Energy Sources and General Lockout Guidelines		
Energy Form	Energy Source	Lockout Guidelines
Electrical Energy	<ul style="list-style-type: none"> Power transmission lines Machine power cords Motors Solenoids Capacitors (stored electrical energy) 	<ul style="list-style-type: none"> Turn off power at machine first (i.e., at point of operation switch), and then at the main disconnect switch for the machine. Lock and tag the main disconnect switch. Fully discharge all capacitive systems (e.g., cycle machine to drain power from capacitors) according to the manufacturer's instructions.
Hydraulic Energy	<ul style="list-style-type: none"> Hydraulic systems (e.g., hydraulic presses, rams, cylinders, hammers) 	<ul style="list-style-type: none"> Shut off, lock (with chains, built-in lockout devices, or lockout attachments) and tag valves. Bleed off and blank lines as necessary.
Pneumatic Energy	<ul style="list-style-type: none"> Pneumatic systems (e.g., lines, pressure reservoirs, accumulators, air surge tanks, rams, cylinders) 	<ul style="list-style-type: none"> Shut off, lock (with chains, built-in lockout devices, or lockout attachments) and tag valves. Bleed off excess air. If pressure cannot be relieved, block any possible movement of machinery.
Kinetic Energy (Energy of a moving object or materials. Moving object may be powered or coasting)	<ul style="list-style-type: none"> Blades Flywheels Materials in supply lines 	<ul style="list-style-type: none"> Stop and block machine parts (e.g. stop flywheels and ensure that they do not recycle). Review entire cycle of mechanical motion, ensure that all motions are stopped. Block material from moving into area of work. Blank as necessary.
Potential Energy (Stored energy that an object has the potential to release due to its position)	<ul style="list-style-type: none"> Springs (e.g., in air brake cylinders) Actuators Counterweights Raised loads Top or movable part of a press or lifting device 	<ul style="list-style-type: none"> If possible, lower all suspended parts and loads to the lowest (rest) position. Block parts that might be moved by gravity. Release or block spring energy.
Thermal Energy	<ul style="list-style-type: none"> Supply lines Storage tanks and vessels 	<ul style="list-style-type: none"> Shut off, lock (with chains, built-in lockout devices, or lockout attachments) and tag valves. Bleed off excess liquids or gases. Blank lines as necessary.

3.8 Disposal

**WARNING**

Milacron *Mold-Masters* declines any responsibility for personal injury or personal damage arising from reuse of the individual components, if these parts are used other than for the original and proper intended purpose.

1. Hot runner and system components must be disconnected from the power supply fully and properly before disposal, including electricity, hydraulics, pneumatics and cooling.
2. Ensure that the system to be disposed of is free from fluids. In the case of hydraulic needle valve systems, drain the oil from the lines and cylinders and dispose it in an environmentally responsible manner.
3. The electrical components are to be dismantled, separating them accordingly as environmentally-friendly waste or disposed as hazardous waste if necessary.
4. Remove the wiring. The electronic components are to be disposed in accordance with the national electric scrap ordinance.
5. The metal parts are to be returned for metal recycling (waste metal and scrap trade). The instructions of the corresponding waste disposal company are to be observed in this case.

Recycling of the materials occupies a forefront position during the disposal process.

3.9 E-Drive Safety Hazards



WARNING - ELECTRIC SHOCK HAZARD

Most controller warnings pertain to electrical hazards. It is crucial to comply with these warnings to minimize any personal danger.

- DO NOT enter the cabinet without first ISOLATING the supplies. As a three-phase supply is used, this potential may be 600 volts or higher.
- High voltage and amperage cables are connected to the controller and the mold. There is also a high voltage cable connection between the servo motor and the controller. Electrical power must be shut off and lockout / tagout procedures followed prior to installing or removing any cables.
- The main power disconnect is a 20A breaker located at the connector end of the cabinet. This main power switch is used to safely disconnect the total load current at the time of switch on and switch off.
- The main power switch can be locked using a padlock applied under the lockout / tagout procedure found in “3.7 Electrical Lockout” on page 3-10.
- Use lockout / tagout to prevent operation during maintenance.
- All maintenance should be performed by properly trained personnel based on local laws and regulation. Electrical products may not be grounded when removed from the assembled or normal operating condition.
- Ensure proper grounding of all electrical components before performing any maintenance to avoid potential risk of electrical shock.

3.9.1 Operational Environment



WARNING

- The display console and controller cabinet together are designed for use in the plastic injection molding industry as with Milacron and third party servo gate control, commonly used in mold tools. They must not be used in residential, commercial or light industrial environments. They must not be used in an explosive atmosphere or where there is a possibility of such an atmosphere.
- The controller cabinet and its touchscreen console should be installed in a clean and dry environment where the ambient conditions do not exceed the limits that follow:
 - Temperature +5 to +45°C
 - Relative Humidity 90% (non-condensing)
- Do not make changes to the factory settings without the help of *Mold-Masters* service personnel. Changes to these settings can result in hazardous out-of-control or unexpected movement. It can also damage the machine, and it will void the warranty.

3.10 Ground Connections

Ground connections are on the M5 self-clinching studs attached to the panels of the E-Drive cabinet.



Section 4 - E-Drive



WARNING

Ensure that you have fully read "Section 3 - Safety" before assembling, integrating or operating the E-Drive system.

4.1 Typical System

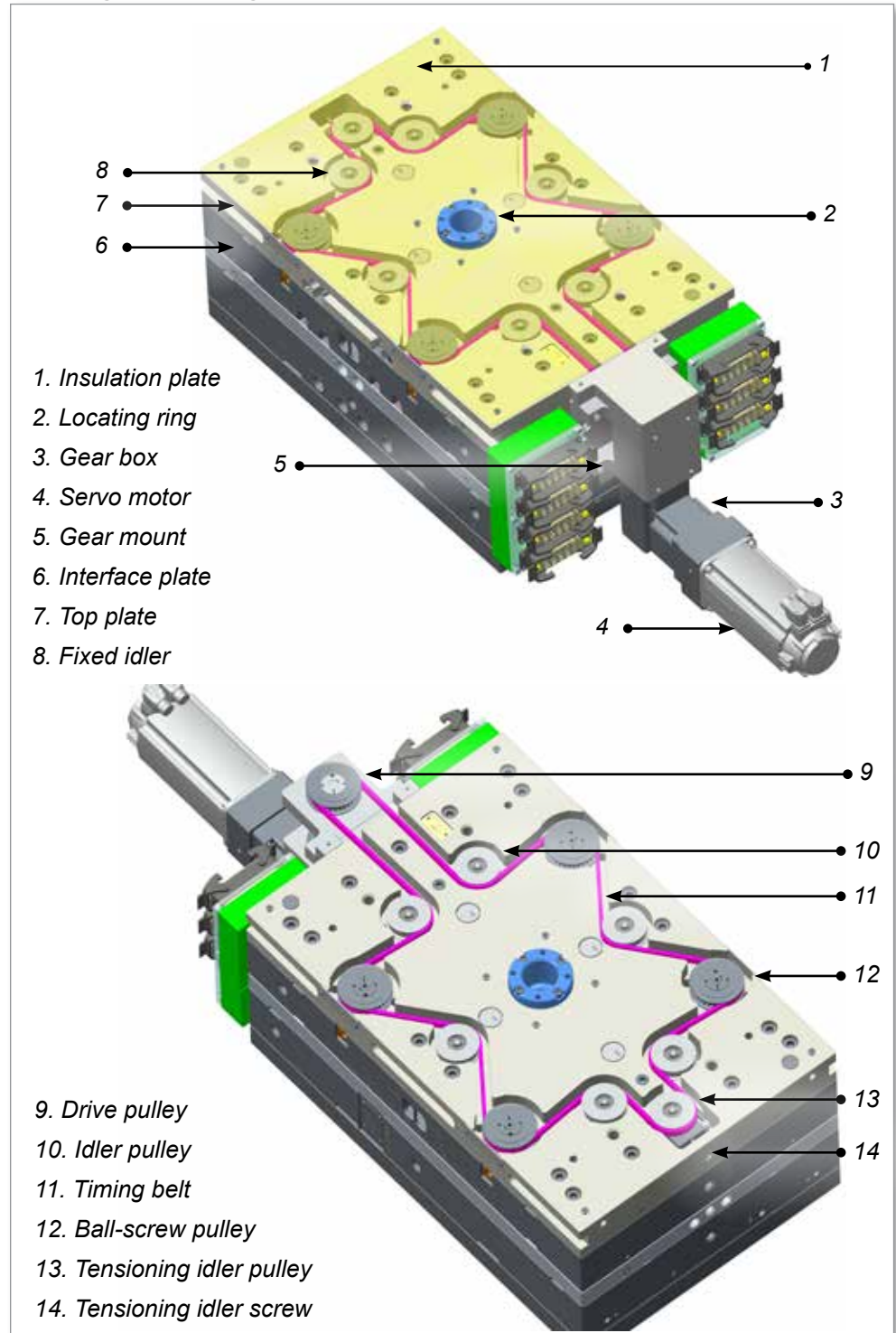

Figure 4-1 E-Drive system

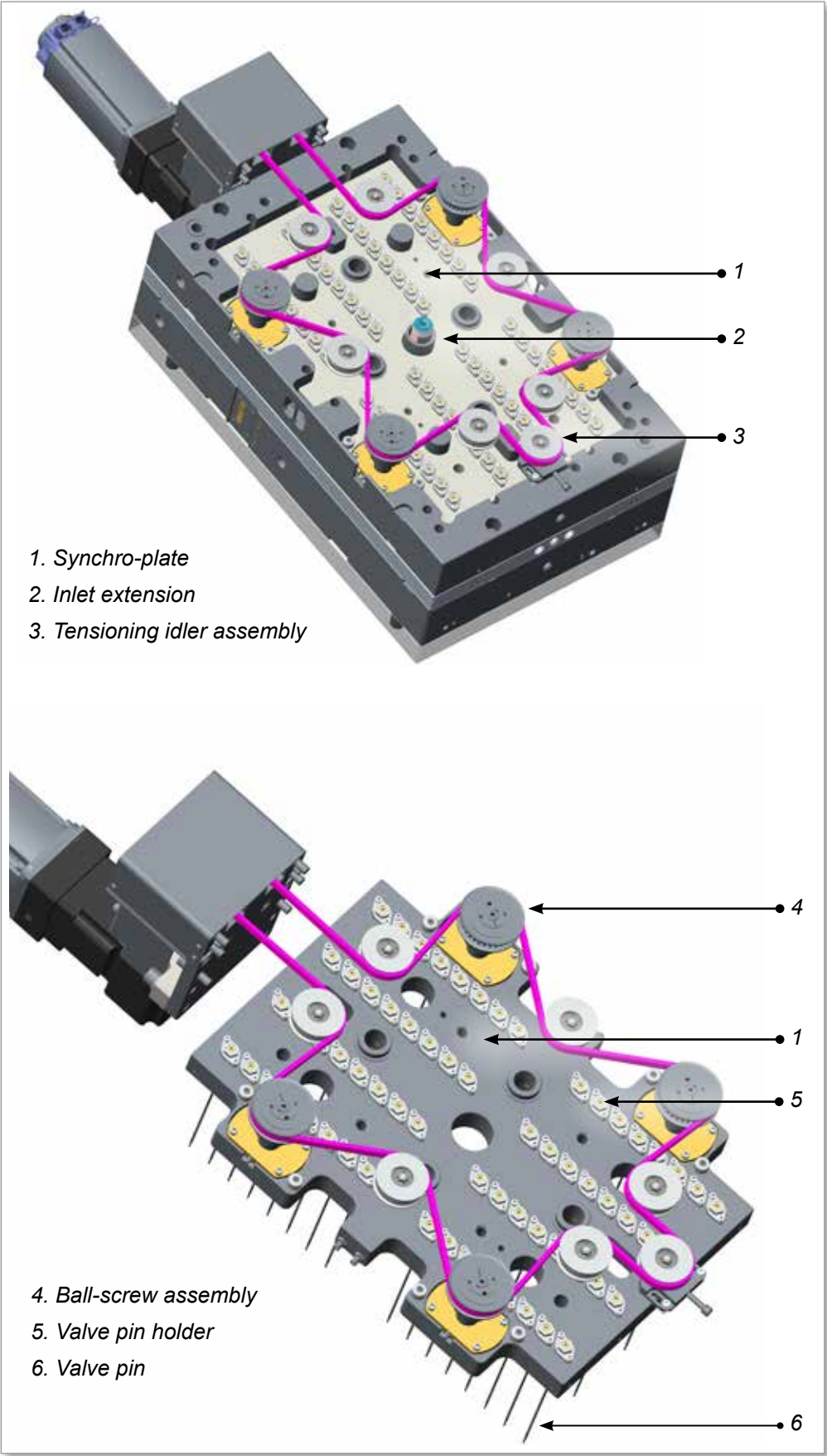

Figure 4-2 E-Drive system (continued)

4.2 Components

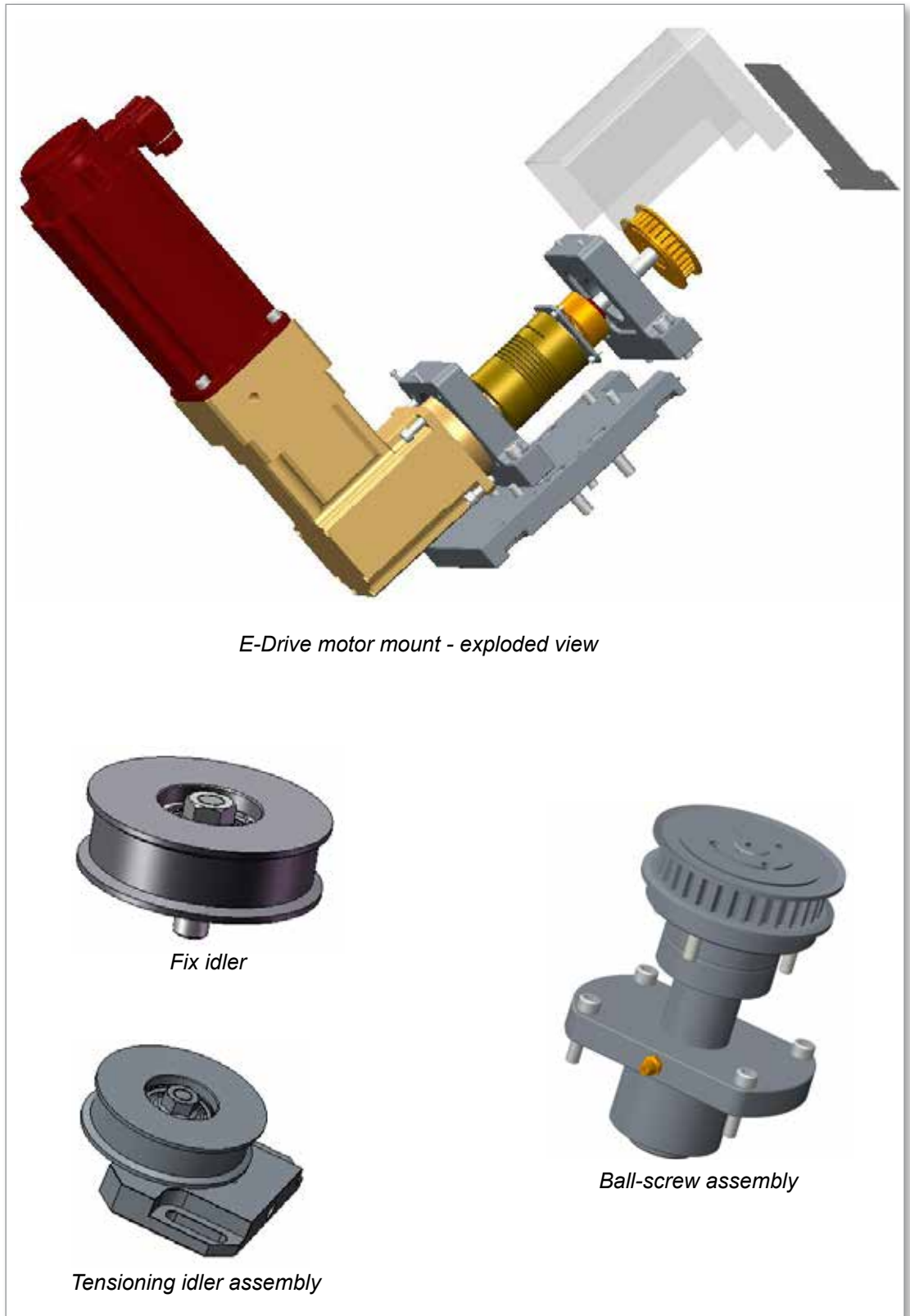

Figure 4-3 E-Drive components

4.3 Safety

Table 4-1 E-Drive Safety Hazards	
Hazard Area	Potential Hazards
	Mechanical Hazards
Entanglement Hazard	Do not operate the equipment with unconfined long hair, loose clothing or jewelry, including name badges, neckties, etc. These may get caught by the moving belt mechanism and can cause death or serious injury.
Entanglement Hazard During Maintenance	Always cover belt area with proper protecting sheet before any bench test or in-mold testing.
Electrical Hazard	<p>Never touch or inspect the timing belt when power is on and E-Drive motor and controller are connected. Unplug the controller before any maintenance.</p> <p>High Voltage and amperage cables are connected to E-Drive controller (400VAC). Also there is high voltage cable connection between servo motor and controller. Heaters, servo motors and electrical components in the controllers could come in contact with a person. Always disconnect and use proper lock out procedures before performing any maintenance work.</p>
Trip Hazard	Controller cables are a tripping hazard on the floor between the controller and the mold.
	Combination Hazards
Failure / Disorder of Control System	<p>Mixed-up connections of the motor power cables on dual motor units may result in an out-of-control or unexpected movement causing damage to the machine and a possible hazard should the machine fail.</p> <p>Do not swap E-Drive controllers for different E-Drive systems without checking manual as controller setup must match mechanical system as it may result in an out-of-control or unexpected movement causing damage to the machine and a possible hazard should the machine fail.</p>



CAUTION

Make sure the controller power supply is unplugged or turned off before plugging in the cables of the motor. Otherwise it can cause damage to the motor. Do not “hot-plug” the motor.

Carefully read the instructions before operating the equipment. If in doubt, contact *Mold-Masters* for clarification.

E-Drive components are rated to operate at temperatures less than 40 °C (104°F). Do not heat the Hot Runner system without connecting a proper cooling system.

In addition, if your application mold temperature needs to be set above 40 °C (104 °F). Use proper mold design for higher temperatures.

4.4 Assembly



WARNING

Review “Section 3 - Safety” on page 3-1 before performing any assembly procedures.

The *Mold-Masters* E-Drive system is shipped pre-assembled and requires minimal pre-installation assembly. The following details the assembly / installation procedures for various components of the E-Drive.

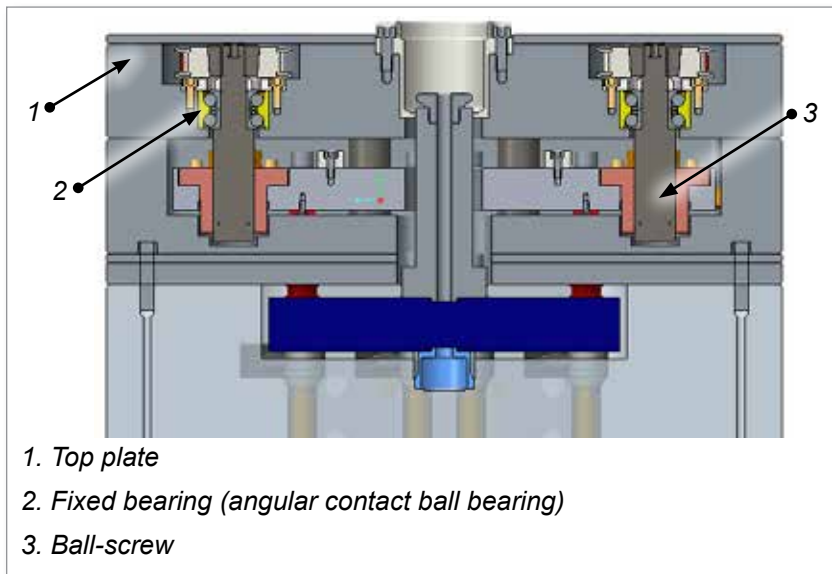
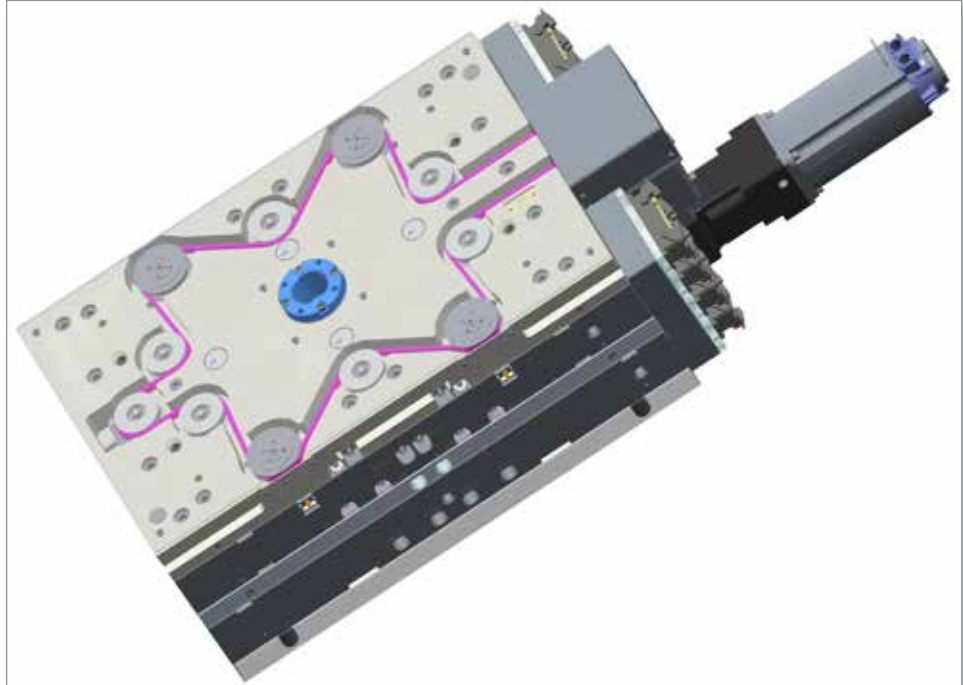
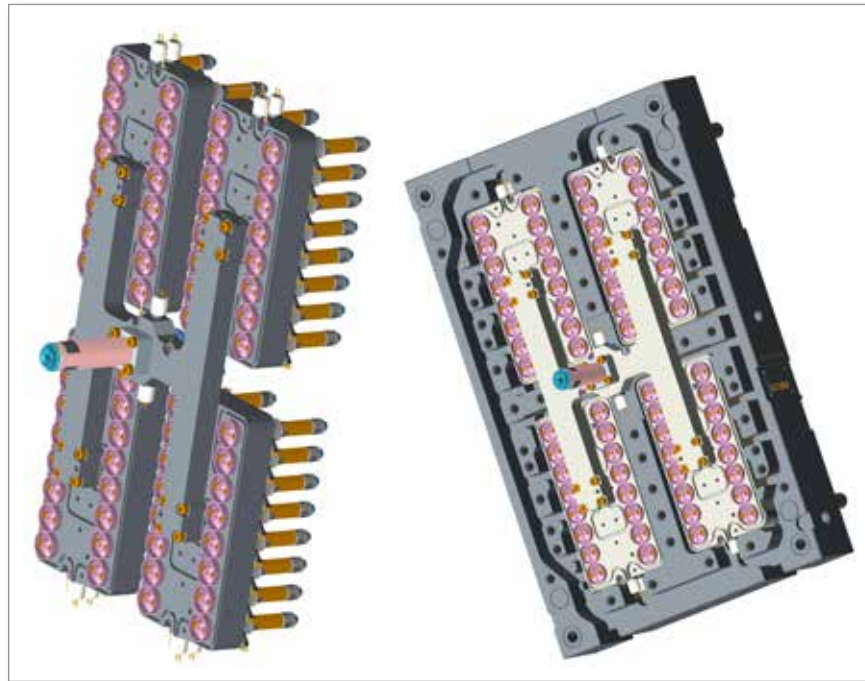

Figure 4-4 Complete assembly (center section)

4.5 Attaching a Hot Runner Assembly

1. Attach the Hot Runner system to the manifold plate.



4.6 Attaching an Interface Plate Assembly

1. Attach the interface plate to the manifold plate.
2. Install the fastening screws to join the plates.

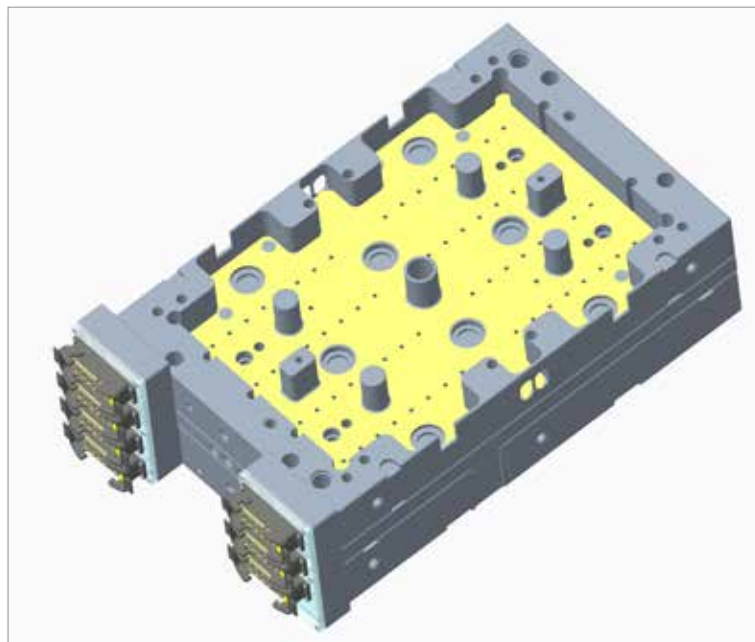

4.7 Assembling a Synchro-Plate

1. Install the synchro-plate without ball nuts in the cutout of the interface plate.

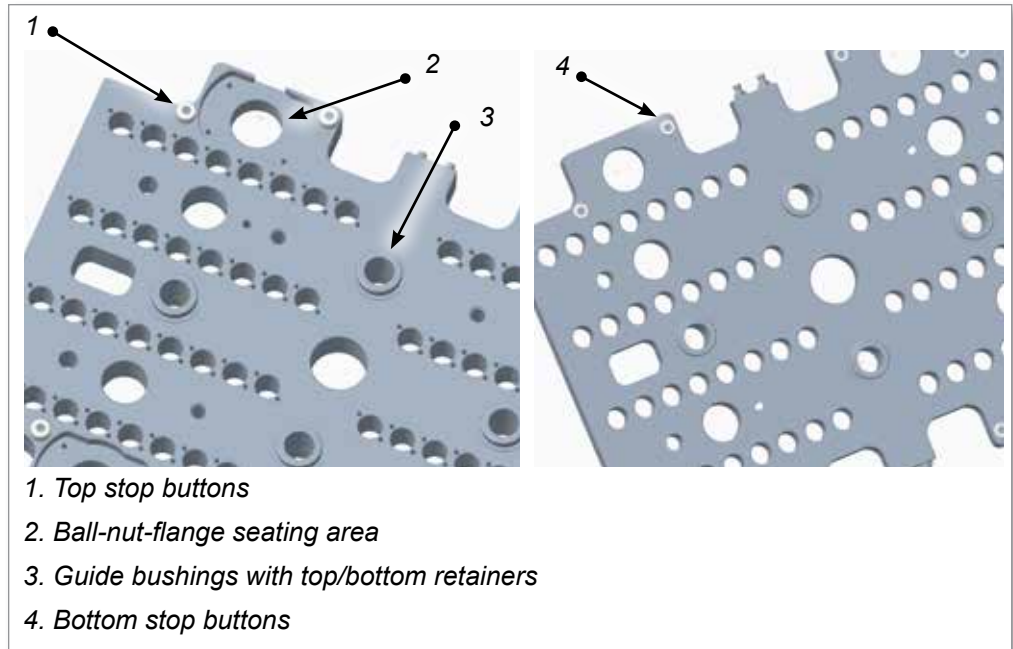

2. Install the valve pin holders in the synchro-plate.

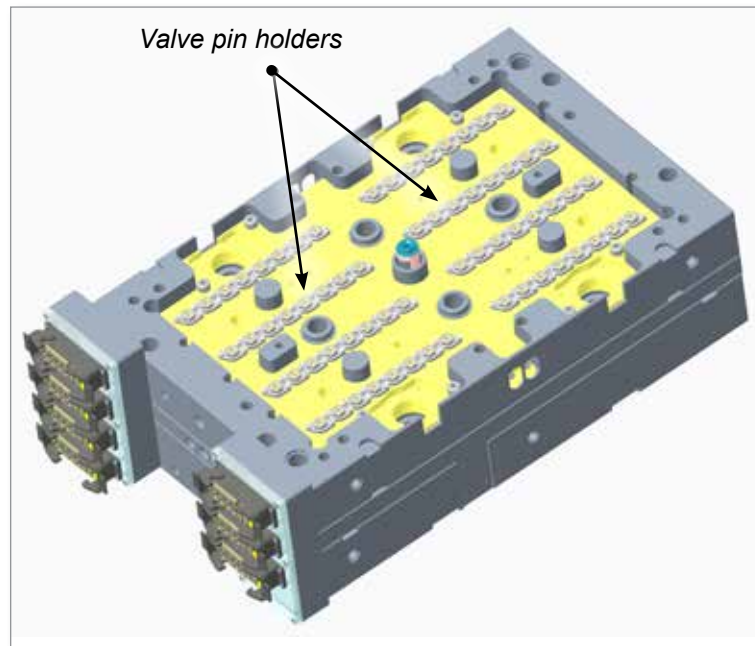

4.8 Preparing a Ball Screw

1. Assemble the ball-screw and fixed bearing.
2. Tighten the ball-screw nut (M20 x 1.0) to a torque 43-45 Nm (31.7 to 33.1 lbf-ft).
3. Make sure that the bearing is properly seated.



4.9 Lubricating a Ball Screw



WARNING

Wear proper gloves and face mask when you apply lubricant to the ball screws. It contains hazardous chemicals.



CAUTION

Do not install the ball screw without lubrication. Doing so may damage the part. Use a Mold-Masters recommended lubricant. Please contact Mold-Masters to order a lubricant or to get a list of recommended lubricants. Do not use graphite- or MoS₂-based lubricants. They will reduce the lifetime of the ball screws.

1. Move the ball-screw nut to one end (position 1) of the spindle.
2. Use a grease gun and apply approximately 3 g of lubricant onto the ball-screw nut.
3. Move the ball-screw to the other end (position 2) of the spindle and bring it back to position 1. Take precautions to keep it away from the dirt.

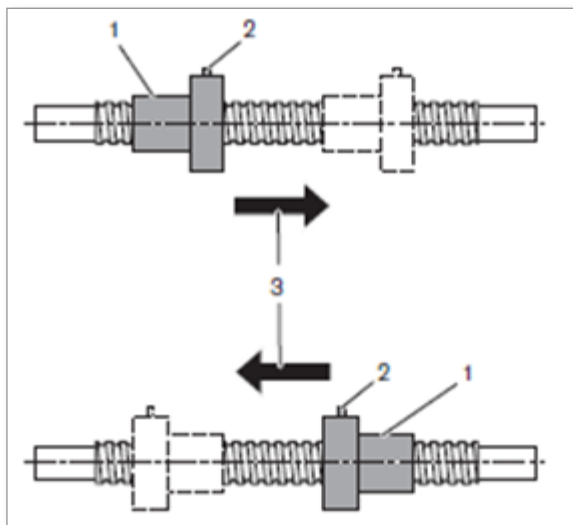

4.10 Assembling a Ball Screw

1. Assemble the ball-screw to the top plate (press-fit). Bearing will protrude 0.10 mm (0.004 in.) to seal with the cover.



2. Install the cover plate into position.



3. Assemble ball-nut on ball-screw with a torque of 43-45 Nm (31.7 to 33.1 lbf-ft).



NOTE

Ball-screw mounting kit EDRIVEBSMNTKITP is supplied with the system.



4.11 Assembling a Top Plate

1. Make sure that the flange-nuts are at proper orientation and same level before top-plate is lowered down for assembly.
2. Install the top plate with the ball-screw to the synchro-plate.
3. Install the motor and the gearbox to the unit.
4. Install the tension idler pulleys to the top plate.

4.12 Attaching a Synchro-Plate to a Top Plate Assembly

1. Using tool KEY-BPHEXTKEY5.0, place the M6 screws that connect the ball-nut to the synchro-plate and slightly tighten them. Use another hex key tool and fully tighten the screws.

4.13 Assembling a Tension Belt

1. Install the ball screw pulleys and belt on the top plate assembly.
2. Do not lock the belt pulley to the screw shaft. Make sure that the shaft does not rotate when the pulleys are rotated.

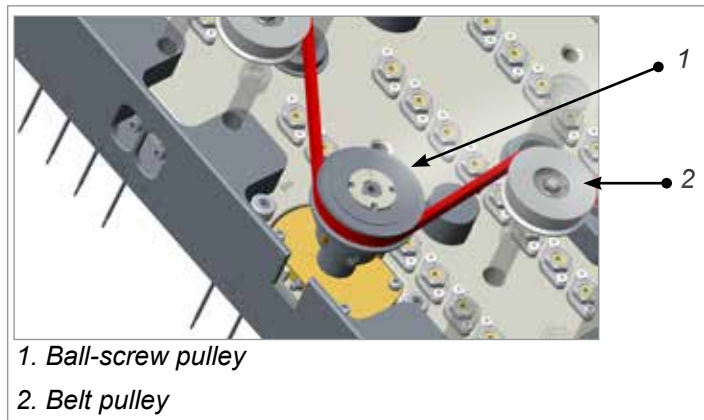

3. Fasten the tension belt to the pulleys.



NOTE

Refer to Section 8 on page 8-1 for the first time installation and replacement of the belt.

4. Tension the belt with the idler tensioning screw to 300 N (67 lbf). Measure the tension in the belt as follows:



NOTE

Use a Sonic tension meter and follow the Span vibration tension method to measure the belt tension.

Measure the belt tension in the longest distance between two pulleys. In your system, the longest distance is the point on the belt that is next to the name plate.

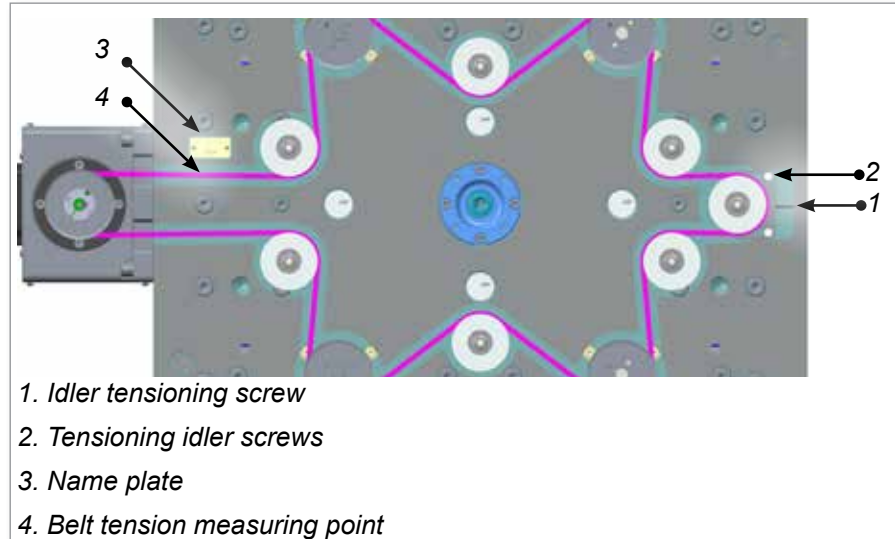

- 1. Idler tensioning screw
- 2. Tensioning idler screws
- 3. Name plate
- 4. Belt tension measuring point

- a) Enter the values of belt density, width and span length to the Sonic tension meter. Refer the name plate for the required information.
 - Belt density (M) : 004.7 g/m (fixed value)
 - Belt width (W) : 012.0 mm/R (fixed value)
 - Span length (S) : Variable value, see timing belt selection page

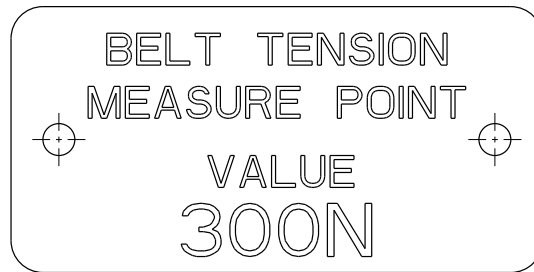

- b) Tap the longest belt span.
- c) Press the “measure” button on the sonic meter and hold the microphone at 1/4 in. away from the back of the belt.
- d) Check the tension and span vibration frequency values in the meter. If required, adjust the tensioning idler screw and make sure that the tension in the belt is 300 N (67 lbf).
- 5. Tighten the tensioning idler screws. Inspecting the Parallelism of the Synchro-Plate



CAUTION

Do not run the E-Drive when the synchro-plate is not in the parallel position. It will damage the part.

- 1. Use the depth gauge tools and inspect the parallelism with the help of the measuring holes provided in the system.

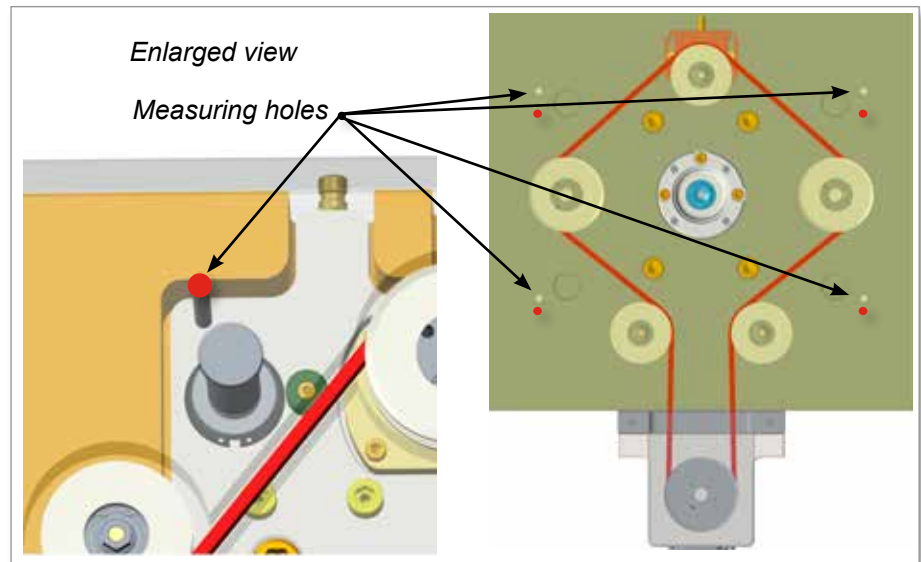

2. Once the parallelism is confirmed, tighten the screws (2 Nos) in each ball-screw pulley.

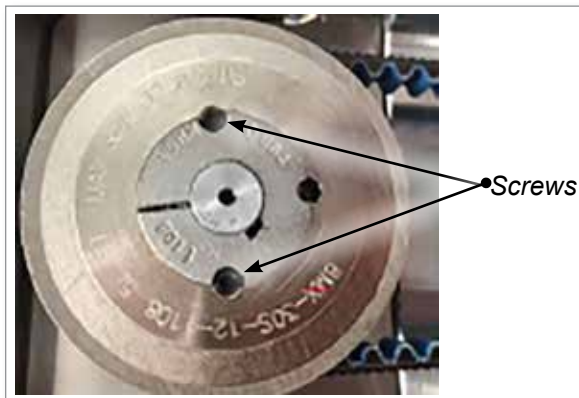

4.14 Assembling an Insulation Plate and a Locating Ring



4.15 Doing E-Drive Controller Checks

Follow the procedures listed in the E-drive controller user manual and perform the E-drive controller checks.

4.16 Installing a Hot Half in a Mold



CAUTION

Make sure the synchro-plate valve pins are at the open position before shipping.

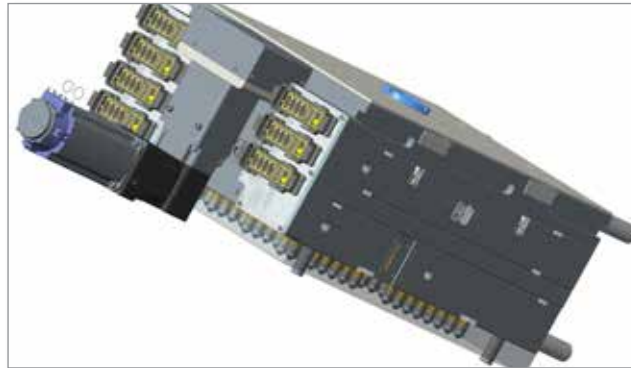

4.17 Installing or Replacing a Belt

1. If system is new and no plastic is inside, move the synchro-plate to home position (fully open position). With proper hex keys on top of ball-screws, rotate clockwise. If system has run plastic before, make sure you heat up the system before moving the synchro-plate to fully open position. In such a case, attach cooling lines to cooling system and make sure that mold

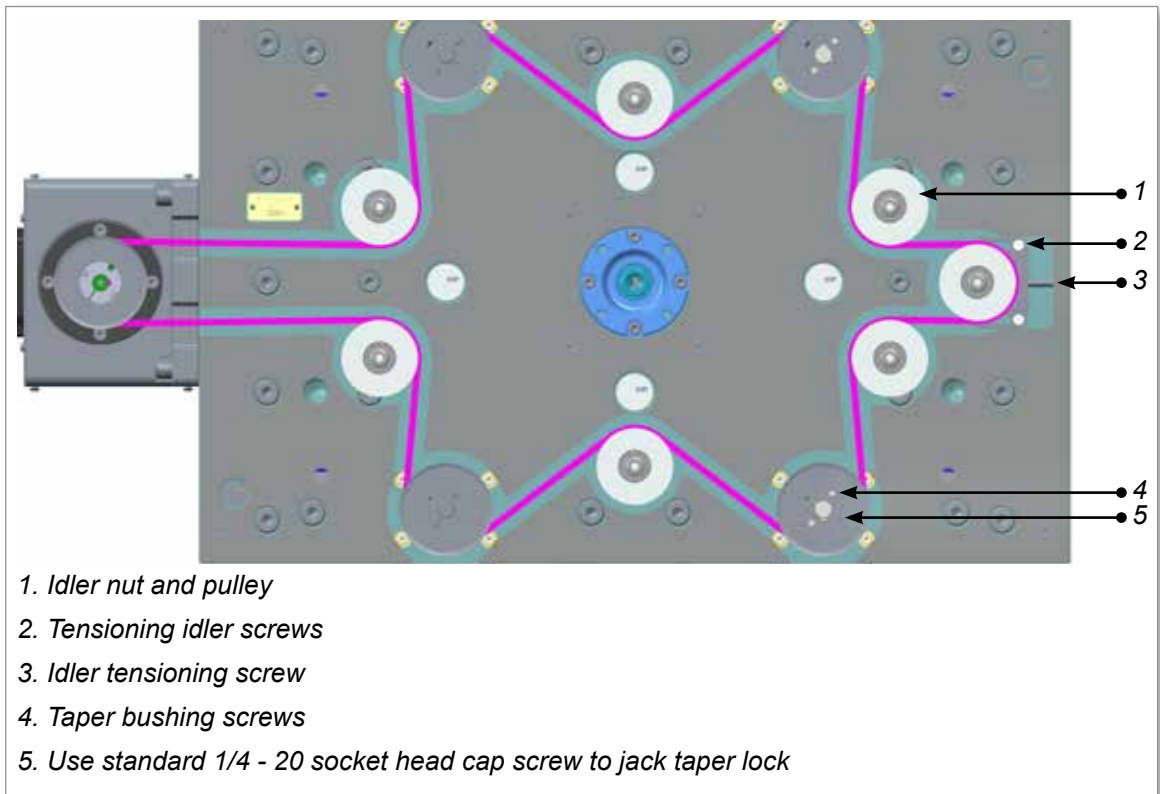

Figure 4-5 Installation or replacement of the belt

temperature will not exceed 40 °C (104 °F) for E-Drive plates.

2. Remove tension from belt completely from tensioning idler.
3. Loosen nuts above one idler without teeth and remove the idler pulley, to allow inserting the belt in tight-belt conditions.
4. Remove the taper bushing set screws on top of both ball-screw pulleys (1/4-20 UNC).

**NOTE**

Use another standard ¼-20 socket head cap screw to jack the pulley until it releases. Make sure synchro-plate remains all the way up and seated flat.

5. Replace the belt.
6. Put back the idler without teeth and tighten the nuts.
7. Install the taper bushing allowing the pulley to still rotate (not gripping yet).
8. Apply slight tension to engage two pulleys (check elevation of pulleys).
9. Time both ball-screw pulleys to engage in same way.
10. Tighten the taper bushing set screws on top of ballscrew pulleys. Make sure the pulleys are at proper elevation and synchro-plate remains flat and seated. Do not apply more than 0.56 Nm (80 lb-in) torque to the set screws.
11. Tension the belt with the idler tensioning screw to 300 N (67 lbf).

**NOTE**

Refer “7.7 Main Screen” on page 7-5 for the instructions to measure the tension in the belt.

12. Tighten the tensioning idler screws.
13. Do the same in all the ball-screws.
14. Check belt height all around and make sure it is in middle of all pulleys and not rubbing on sides. Measure depth of belt at various places and check alignments.
15. If possible, while system is heated, do a few dry cycles (using 24 V_{DC} manual trigger) and check movement and noise. Double check the position of belt within all pulleys. See E-Drive Controller Operating Manual.

4.18 Doing a Check for Misalignment

During belt installation and drive alignment, two types of misalignment can occur:

- Parallel misalignment - is when driveR and driveN shafts are parallel, but the two pulleys lie in different planes.
- Angular misalignment - is when the two shafts are not parallel.

A fleeting angle is the angle at which the belt enters and exits the pulleys, and it equals the sum of the parallel and angular misalignments.

Any degree of pulley misalignment will result in some reduction of belt life, which is not accounted for in the normal drive design procedure.

Misalignment of all positive belt drives should not exceed $1/4^\circ$ or 5 mm per metre of centre distance.

Misalignment should be checked with a good straight edge tool. The tool should be applied from driveR to driveN and from driveN to driveR so that the effect of parallel and angular misalignment is taken into account.

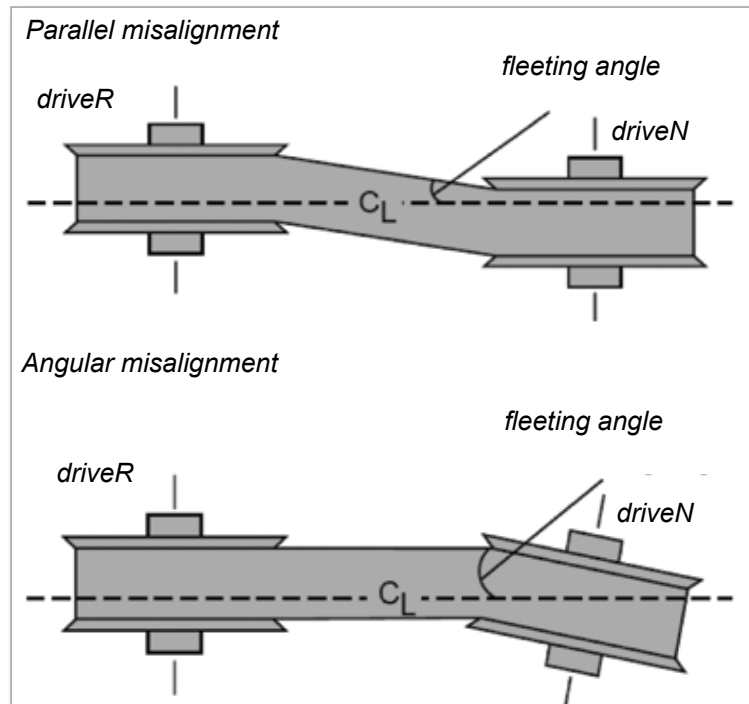

Figure 4-6 Misalignment check

Section 5 - Mag-Pin Option



WARNING

Ensure that you have fully read “Section 3 - Safety” before assembling or installing the Mag-Pin option.

This section provides the information for the assembly / installation of the Mag-Pin (Magnetic Valve Pin holder) which is an optional component.

The Mag-Pin mechanism helps in the deactivation of individual valve pins in the synchro-plate design. The advantage of this system is that the mold plates do not need to be open to do this. A deactivated valve pin will remain in the closed position. This provides the ability to select and shut down any cavity in a synchro-plate design.



NOTE

Deactivation of the magnets must be only used as a temporary solution.

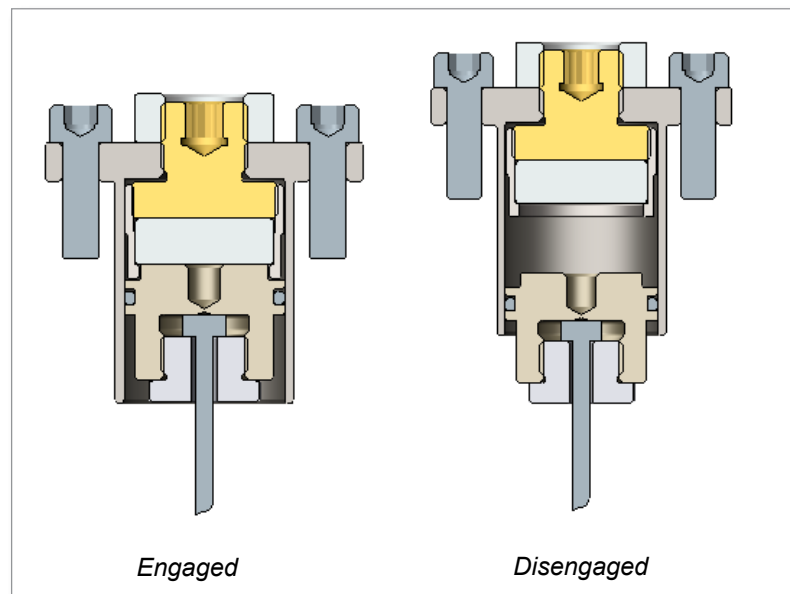

Do not use the Mag-Pin option for the conditions that follow:

- To mold soft and elastic materials with Durometer hardness (Style A) less than 90 (for very short length nozzles in particular)
- To mold viscous materials with long nozzles
- Accu-Valve CX gate style

To use the Mag-Pin option, consider the factors that follow:

- Plastic material
- Nozzle length
- Valve pin size: 2.5 and 3 mm (0.1 and 0.12 in.) diameter valve pins
- Gate style



NOTE

Please contact *Mold-Masters* to understand if the Mag-Pin option is applicable to your product.

5.1 Assembly

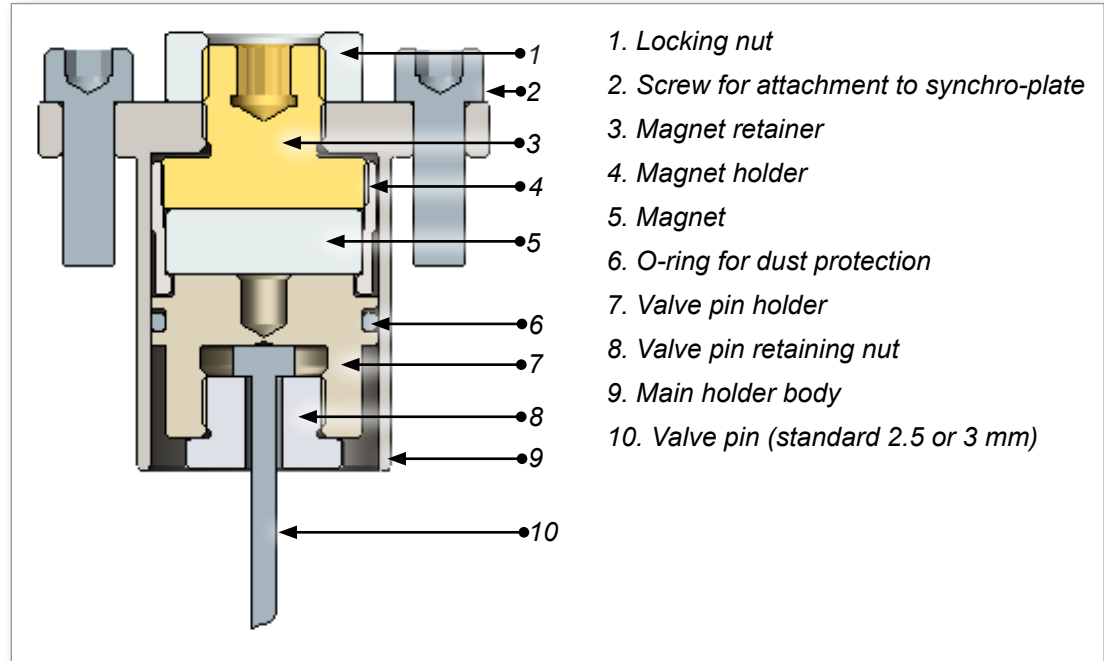

Figure 5-1 Mag-Pin assembly

5.2 Safety



WARNING - STRONG MAGNETIC FIELD HAZARDS

Persons with pacemakers or other metallic, electronic, magnetic implants, devices or objects shall not enter the magnetic field area.

Do not keep any tools or metal objects in the magnetic field area. Failure to follow the instructions can cause injury to personnel and / or damage to the parts.



Figure 5-2 Mag-Pin safety hazards

5.3 Operation



CAUTION

Do not turn off the nozzle. It may result in leakage.

Normal condition:

- Nozzle is at processing temperature and the gate is active.
- Force of the magnet is high enough to hold the valve pin that is attached to the synchro-plate when the cycle opens.

Deactivated gate:

- With the valve pin in close position, decrease the temperature until the plastic material is frozen. This low temperature plastic around the valve pin holds the pin in the closed position.
- The valve pin separates from the synchro-plate at the magnet interface.

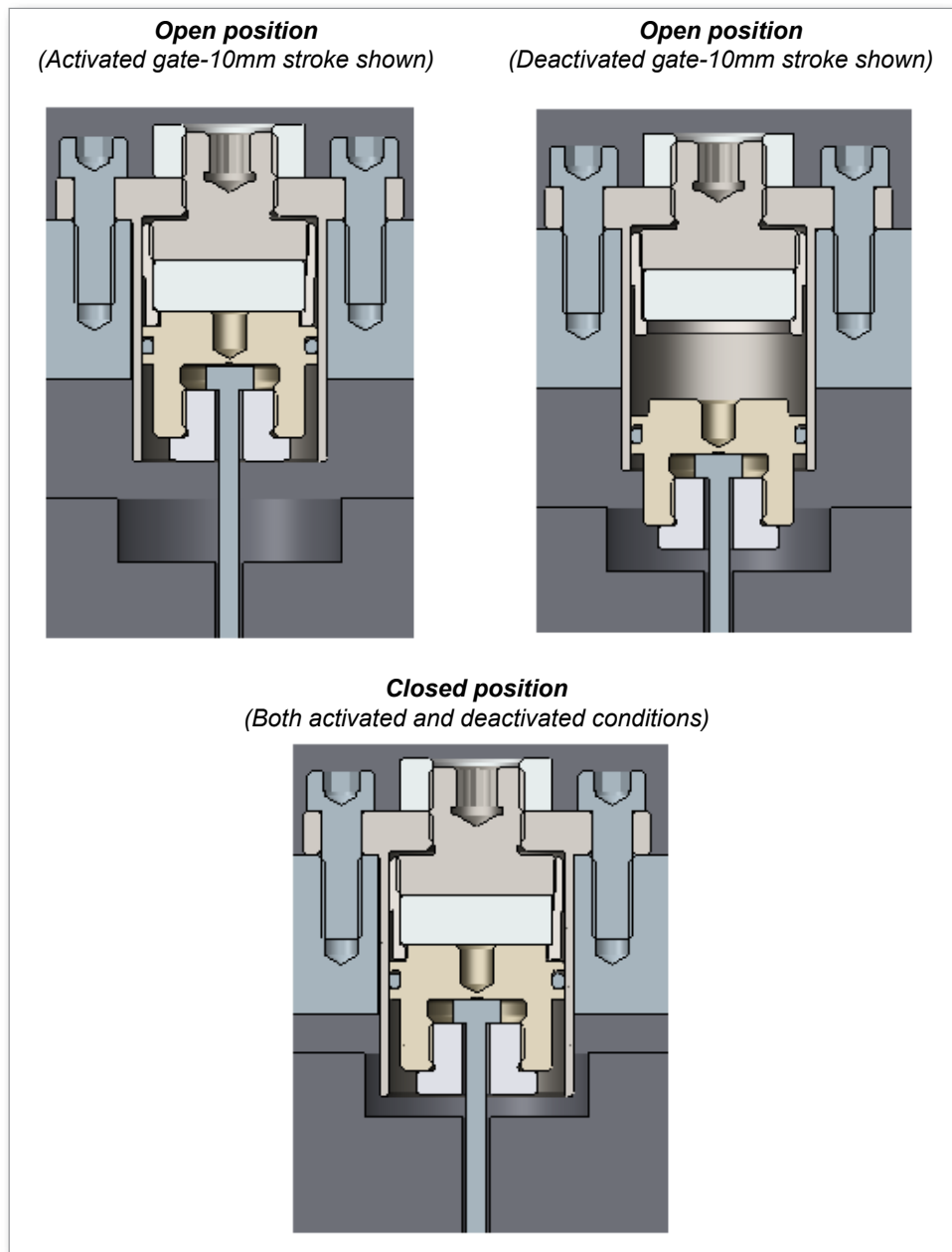

Figure 5-3 Mag-Pin activation / deactivation

Deactivation:

After the nozzle temperature is dropped down, the plastic material around the valve pin holds the pin in its position and it decouples at the magnet interface.

Activation:

After the nozzle is turned on, the plastic material around the valve pin releases the pin and the magnet is engaged at the interface when the actuation starts.

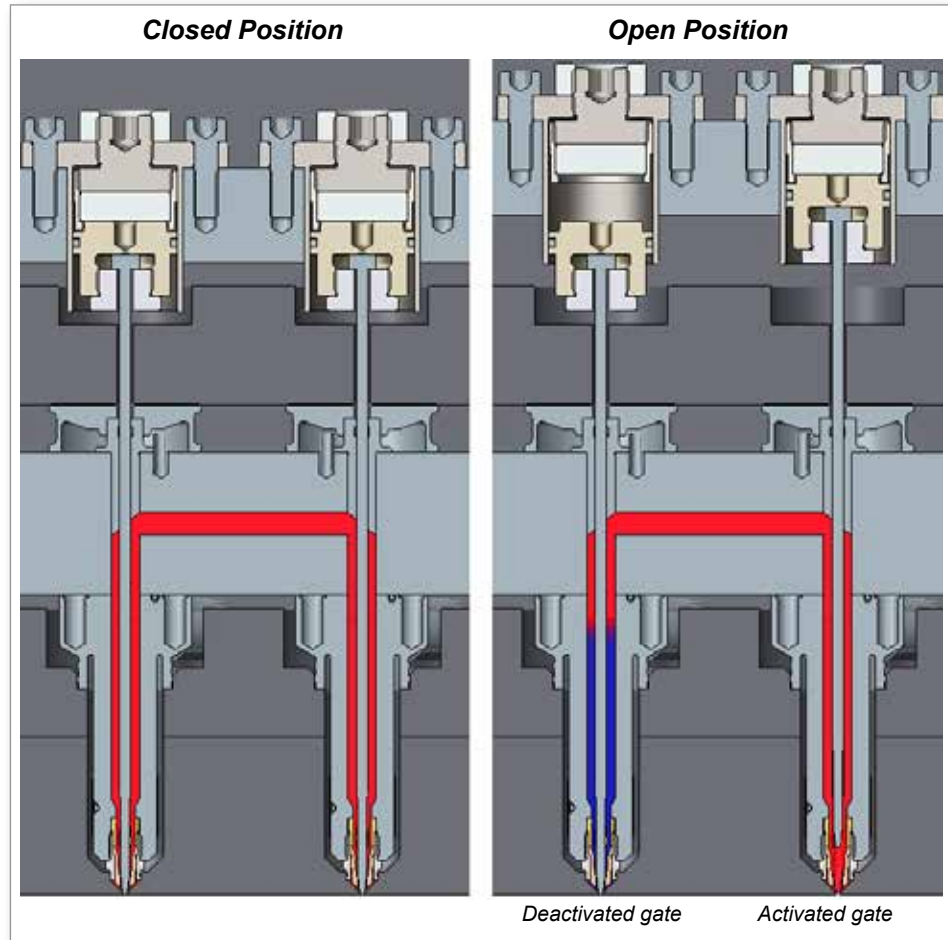

Figure 6-3 Mag-Pin activation / deactivation (continued)

5.3.1 Handling Magnets



WARNING

Be careful of the possible pinch hazards when you handle the magnets.



CAUTION

Use the supplied plastic spacers between the magnets to prevent the contact between them when you handle and store the magnets.

Make sure that you keep the groups of magnets in a thick plastic container to avoid impact with other parts or tools.

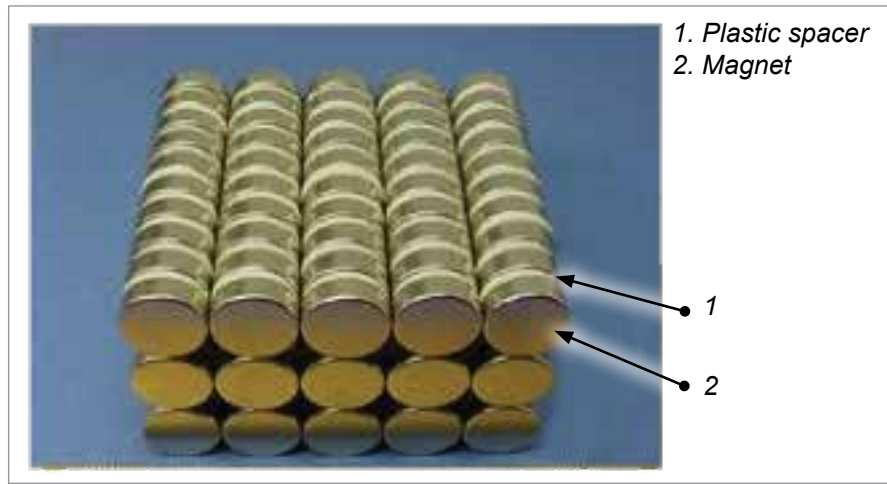

5.3.2 Summary of the Assembly Procedure

1. "Lockout Safety" on page 3-9
2. "Checking the Polarity of a Magnet" on page 5-7
3. "Cleaning a Magnet Holder" on page 5-7
4. "Installing a Magnetic Retainer in a Magnet Holder" on page 5-8
5. "Placing a Magnet Holder and Magnet into a Housing" on page 5-8
6. "Assembling a Nut and a Lock Magnet Holder" on page 5-9
7. "Installing a Valve Pin in a Valve Pin Holder" on page 5-9
8. "Installing an O-Ring in a Valve Pin Holder" on page 5-10
9. "Installing a Valve Pin in a Housing Assembly" on page 5-10
10. "Installing a Mag-Pin Assembly in a Synchro-Plate" on page 5-11

5.3.3 Assembling



WARNING

Be careful of the possible pinch hazards when you handle the magnets. Store the magnets in a safe and thick plastic container.



CAUTION

Clean the workbench before the assembly.

Make sure that the work bench is free from metal chips, debris, dust and grinding powder.

Use new rags and clean the parts before the assembly.

Do not place the magnets close to any ferromagnetic parts or other magnets. Their light weight and magnetic strength can cause the magnets to collide which will damage the magnet faces.

5.3.3.1 Placing a Magnet on Top of the Magnet Retainer

1. Install the magnet on top of the magnet retainer.



5.3.3.2 Checking the Polarity of a Magnet

1. Use a compass to check the polarity of magnets before assembly. Flip the magnet if the polarity shown on the magnet is wrong.

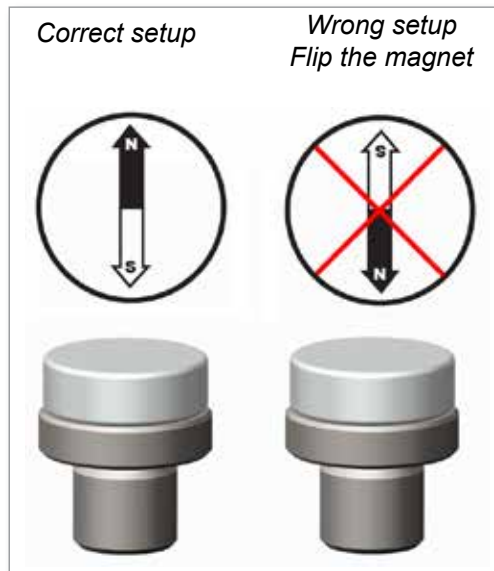

5.3.3.3 Cleaning a Magnet Holder

1. Clean and inspect the magnet holder.
2. Make sure that the interface with the magnet is free from grease, burrs or dust.



5.3.3.4 Installing a Magnetic Retainer in a Magnet Holder

1. Hold the magnet assembly in your hand.
2. Use a 5 mm (0.2 in.) hex key and assemble the magnet retainer to the magnet holder with a torque of 27 to 30 Nm (20 to 22 lbf-ft).



5.3.3.5 Placing a Magnet Holder and Magnet into a Housing

1. Install the magnet holder and magnet into the housing.
2. Use a 5 mm (0.2 in.) hex key and rotate the magnet holder in a counter-clockwise direction until the threaded part protrudes.

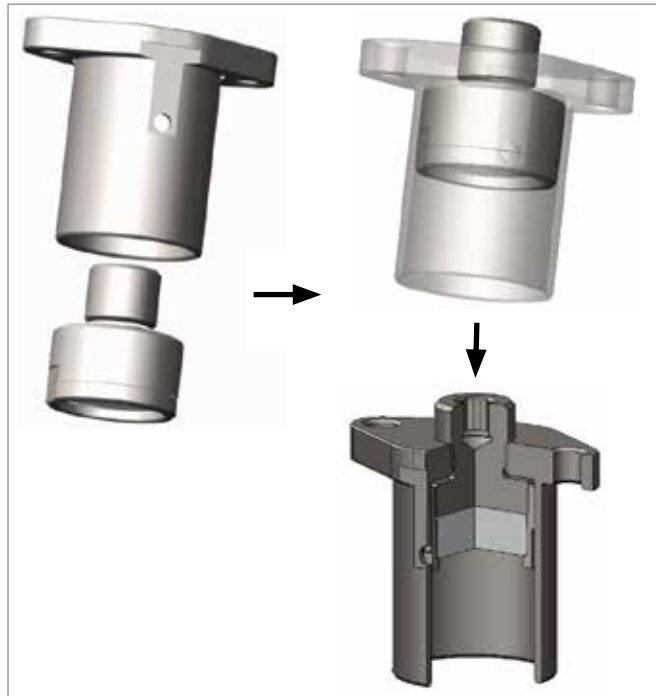

5.3.3.6 Assembling a Nut and a Lock Magnet Holder

1. Make sure that the thread pitch of the jam nut is 1.00 mm (0.04 in.).
2. Assemble the jam nut into the housing.
3. Adjust the height of the jam nut such that there is a 0.50 mm (0.02 in.) gap as shown in Figure 5-7.
4. Assemble the part into the synchro plate in heated condition and examine the valve pin height.
5. Adjust if required and ensure the correct valve pin height.

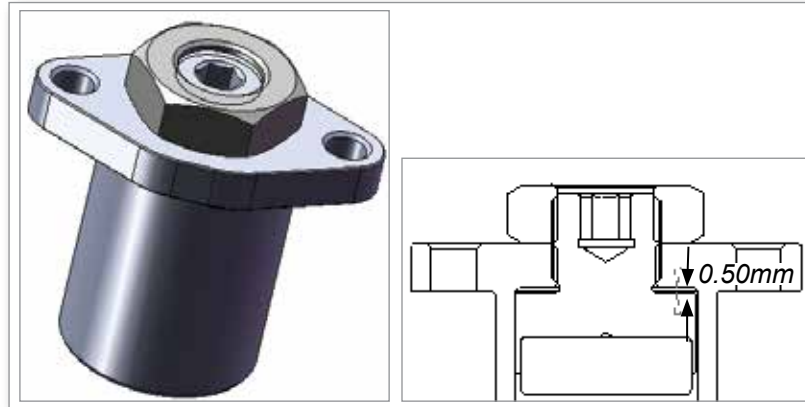
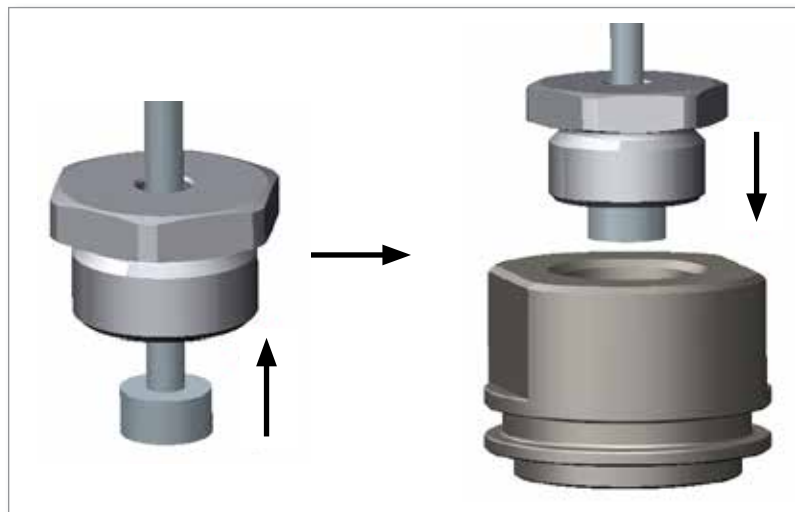

Figure 5-7 Jam nut assembly

5.3.3.8 Installing a Valve Pin in a Valve Pin Holder

1. Insert the valve pin into the valve pin retainer.
2. Hold the valve pin holder with your hand.
3. Use a wrench and assemble the valve pin retainer with valve pin into the valve pin holder.



5.3.3.9 Installing an O-Ring in a Valve Pin Holder

1. Lubricate the O-ring with a thin layer of high temperature grease.
2. Install the O-ring into the correct groove on the valve pin holder.
3. Use a cloth and clean the excessive grease from the top and side faces.

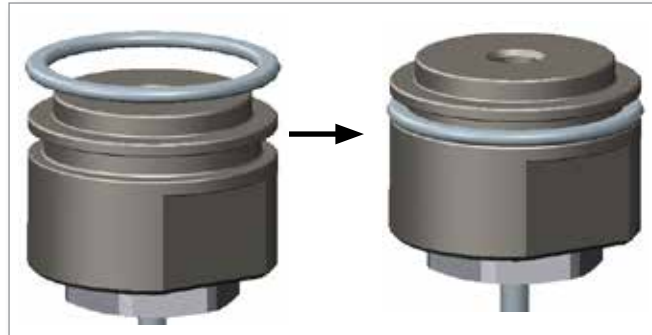

5.3.3.10 Installing a Valve Pin in a Housing Assembly

1. Carefully assemble the valve pin into the housing assembly.
2. Make sure that there are no impact forces on the magnet.

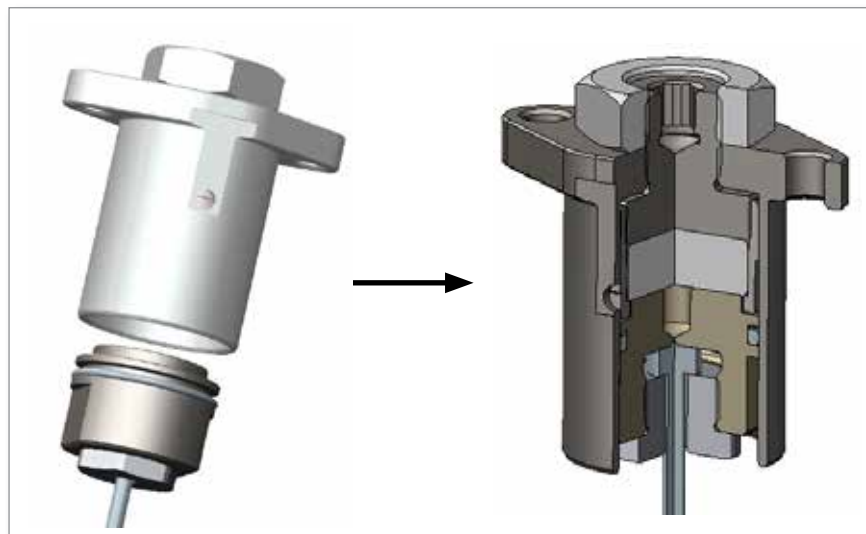

5.3.3.11 Installing a Mag-Pin Assembly in a Synchro-Plate

1. Heat the system and adjust the valve pin height if the valve pin protrusion is not correct.
2. The Mag-Pin assembly at this condition can be installed into the synchro-plate

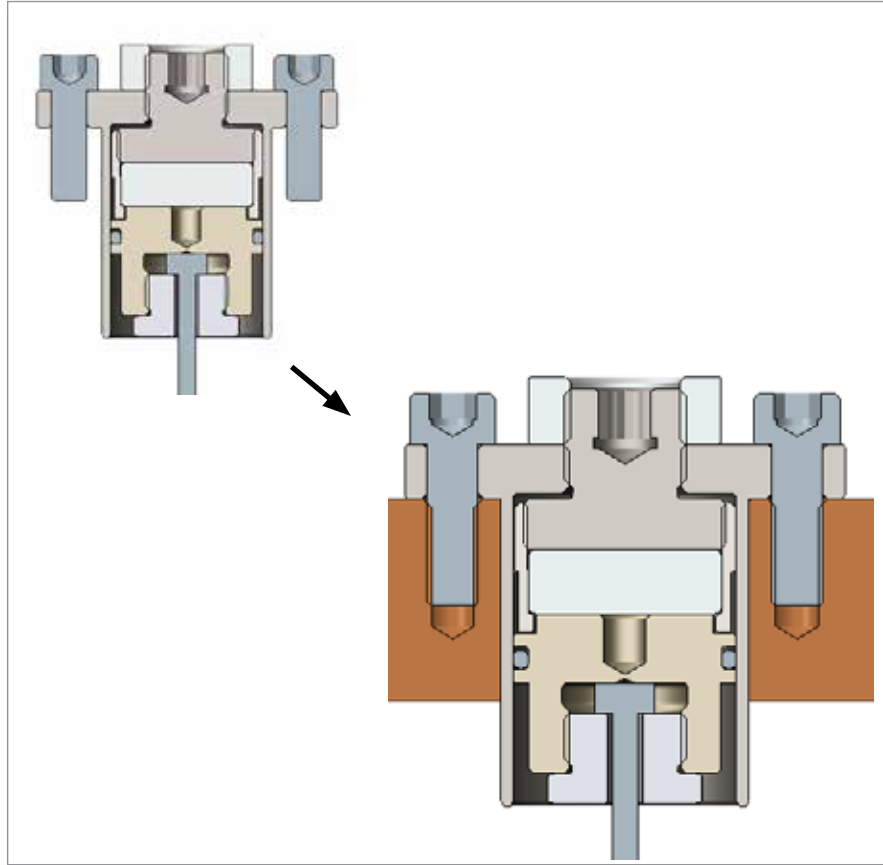

Section 6 - Maintenance

6.1 Ball Screws



CAUTION

If your mold has not been used for a long time, inspect the ball-screws for oxidation and dirt. Clean and lubricate the ball-screws before you start the machine.

We recommend that you have a Mold-Masters service technician perform the inspection.

Regular Maintenance Recommendations

Mold-Masters recommends that you do maintenance on whichever of the following schedules occurs earlier.

Maintenance by cycle: Every 1.6 million cycles

Maintenance by duration: Every six months

Lubrication: Castrol Tribol GR100-2PD (MM part no. COTS0042)

Lubrication volume: 3.5 g

Section 7 - Controller Overview



WARNING

Ensure that you have fully read “Section 3 - Safety” before setting up or operating the E-Drive controller.

It is the responsibility of the integrator to understand and follow international and local standards for safety of machinery when integrating the E-Drive controller into the molding system. This responsibility includes providing necessary e-stop connections, safety interlocks and guarding to protect operators.

The E-Drive controller should be located in such a way that the main disconnect is easily accessible in case of emergency.

The E-Drive controller is shipped with a power cable which is a correct size to run the system. When you install a connector on the cable, ensure that the connector can safely withstand the full system load.

The E-Drive controller supply should have a fused disconnect or main circuit breaker according to local safety codes. Refer to the serial plate on the controller cabinet for confirmation of the supply requirements. If the local supply is outside the specified range, please contact *Mold-Masters* for advice.



WARNING - ELECTRICAL SHOCK HAZARD

It is crucial to comply with the following warnings to minimize potential dangers.

- Ensure that all energies are properly locked out in the controller and molding machine before installation of the controller into the system.
- Do not enter the cabinet without first isolating the supplies. There are unguarded terminals inside the cabinet which may have a dangerous potential across them. Where a three-phase supply is used, this potential may be up to 600VAC.
- Voltage and amperage cables are connected to the controller and the mold. There is also a voltage cable connection between the servo motor and the controller. Electric power must be shut off and lockout/tagout procedures followed prior to installing or removing any cables.
- Integration should be done by properly trained personnel based on local codes and regulations. Electrical products may not be grounded when removed from the assembled or normal operating condition.
- Do not mix electrical power cables with thermocouple extension cables. They are not designed to carry the power load or list accurate temperature readings in each other's application.
- Integration should be done by properly trained personnel based on local law or regulation requirements. Electrical products may not be grounded when removed from the assembled or normal operating condition.
- Do not mix electrical power cables with thermocouple extension cables. They are not designed to carry the power load or list accurate temperature readings in each other's application.

7.1 System Overview

The E-Drive controller is a servo-driven controller for up to two plates that is designed to be used as a stand-alone system.

7.2 Touchscreen Buttons

Inactive buttons are not highlighted (1). Active buttons are highlighted (2).

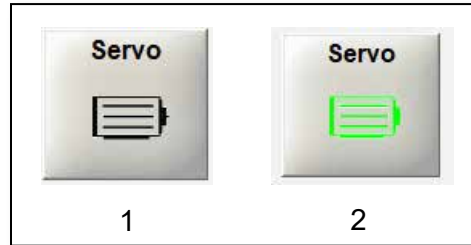

7.3 Configuration



CAUTION

Incorrect configuration of the E-Drive system may cause performance problems and may damage valve pins and gate inserts.

7.4 E-Drive Actuator Models

The E-Drive actuator is available in two models.

Model	Stroke (mm)	Cooled
MSK040C-0600-NN	n.a.	No
MSK061C-0600-NN	n.a.	No

The size and options for the E-Drive actuator depend on the system requirements. Please check your General Assembly drawings to learn the type of E-Drive actuator in your system. An actuator's maximum velocity varies depending on the supply voltage. The possible velocities are shown in the following table.

Voltage—3*AC (V)	MSK040C-0600-NN	MSK061C-0600-NN
	Max speed (mm/s) Based on 8:1, 5 mm/rev	Max speed (mm/s) Based on 8:1, 5 mm/rev
200	37	36
230	43	39
380	70	56
400	74	58
440–500	78	62

For further information about assembly or disassembly of an E-Drive system within a Hot Runner system, please refer to your Hot Runner User Manual.

**IMPORTANT**

The E-Drive controller is not configured to control cooling systems. Mold-Masters assumes no responsibility for connection, monitoring and/or maintenance of any cooling system associated with an E-Drive system.

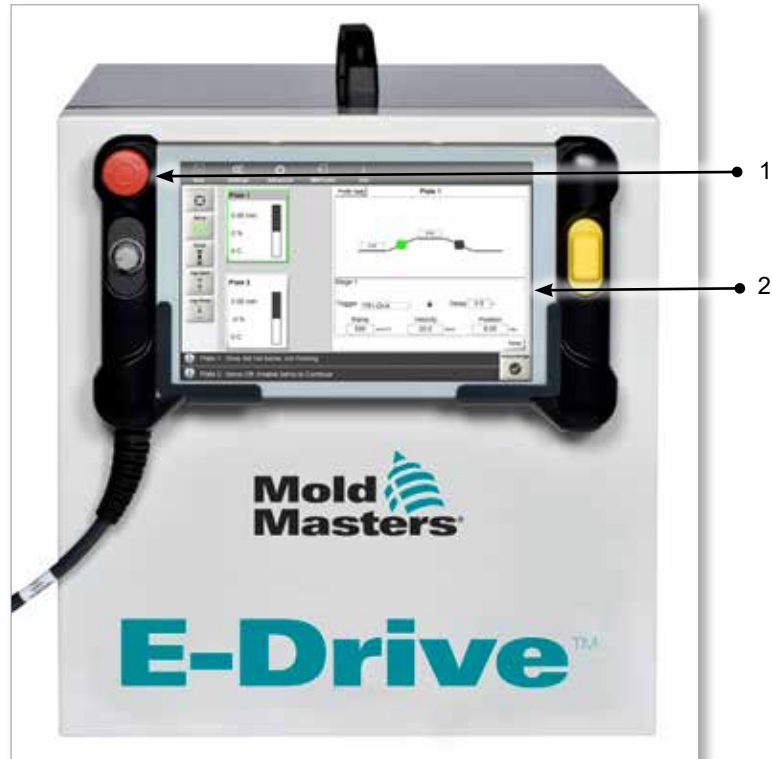
7.5 Controller Front

1. Stop button
2. Touchscreen pendant

7.6 Controller Connections

The controller connections are at the rear of the cabinet.



Figure 7-1 Connections of the E-Drive cabinet

1. Servo motor connections
2. Hot Runner Controller (HRC) input
3. HMI connection
4. Power supply connection
5. Main power switch
6. Trigger input

For more information, see “Section 10 - Wiring Details” on page 10-1.



7.7 Main Screen

The main screen provides information about the E-Drive controller, and displays the buttons used to operate the motion control functions. The touchscreen can display up to two plates.





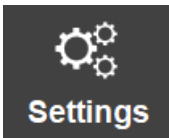
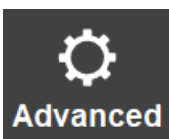
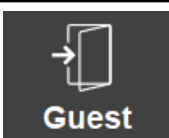



Figure 7-2 Main screen of the E-Drive controller

7.7.1 Top Menu Buttons

Table 7-3 Top Menu Buttons	
Button	Description
 <p>New</p>	To create a new project with new mechanical settings
 <p>Settings</p>	To access the Settings screen
 <p>Advanced</p>	To access digital and analog IO setup and monitoring or to see drive information
 <p>Guest</p>	To log-in
 <p>Info</p>	To see the software version and system information

7.7.2 Side Menu Buttons

Table 7-4 Side Menu Buttons	
Button	Description
	To change between auto and manual modes
	To enable the servo motors
 	To move the plate forward or backward in manual mode
	To home the system
	To move the plate to the close position specified in the motion profile

7.7.3 Bottom Information Bar

The default information displayed in the bottom information bar, from left to right, includes:

- an icon showing the type of message
- a plate number and message
- an acknowledge button

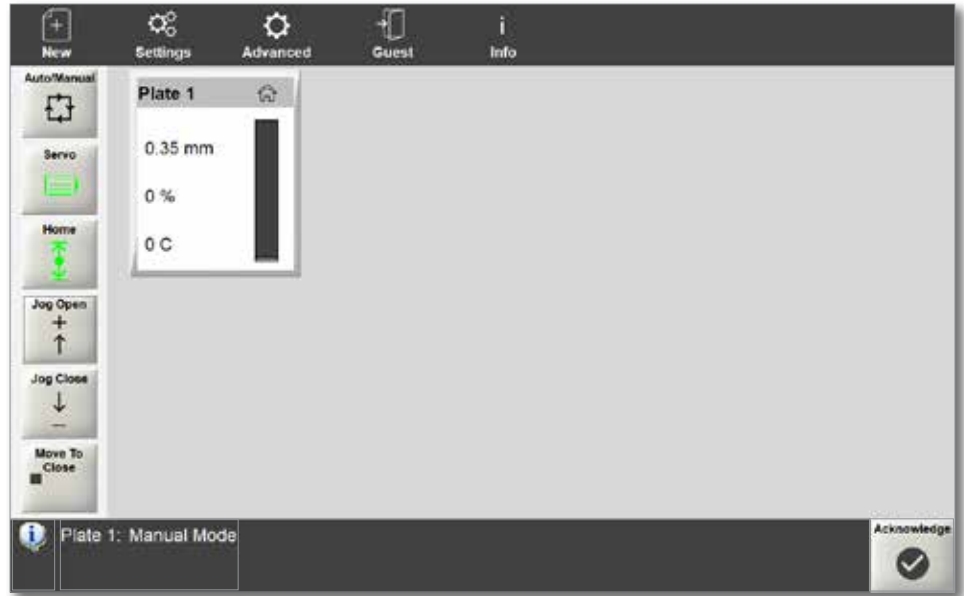

Figure 7-3 Bottom information bar

If an alarm is triggered, the bottom information bar changes and displays:

- the alarm icon
- an alarm description in red
- the acknowledge icon in red

Section 8 - Controller Operation



WARNING

Read “Section 3 - Safety” before setting up or operating the E-Drive controller.

8.1 Powering the Controller



CAUTION

Before you turn on the controller ensure that all motor power and encoder cables are properly connected based on how the cables are labeled.
Any damage to the motor cables can cause performance issues and/or motor failure.



IMPORTANT

Ensure that the mechanical assembly is completed, that the valve pins are connected to the valve pin holder, and that the motor is correctly mounted to the plate or manifold.

For all E-Drive controllers, the main power disconnect is a rotary switch located at the back of the controller. This switch is rated to safely handle the total load current when switched off.

After the bootup process is complete, you will see the default motion control screen. See “7.7 Main Screen” on page 7-5 for more information.

8.2 User Access

There are seven levels of password access for the E-Drive controller.

Levels of Password Control		
User	Default Password	Description
Guest	1	Access includes start or stop and operate the controller
Supervisor	1	In addition to having Guest permissions, a Supervisor can: <ul style="list-style-type: none"> change manual settings create and change profiles
MMTester	Mold-Masters only	Available only to Mold-Masters service technicians

8.3 Logging-in

You can operate the E-Drive system as the default user Guest. For certain changes, you must log-in. The controller has the default password of “1” for Supervisor.



NOTE

Any loss of power to the controller requires the user to log-in again.

1. Choose **Guest**.

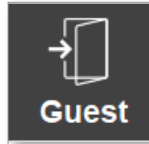

The Log On dialog box is displayed.

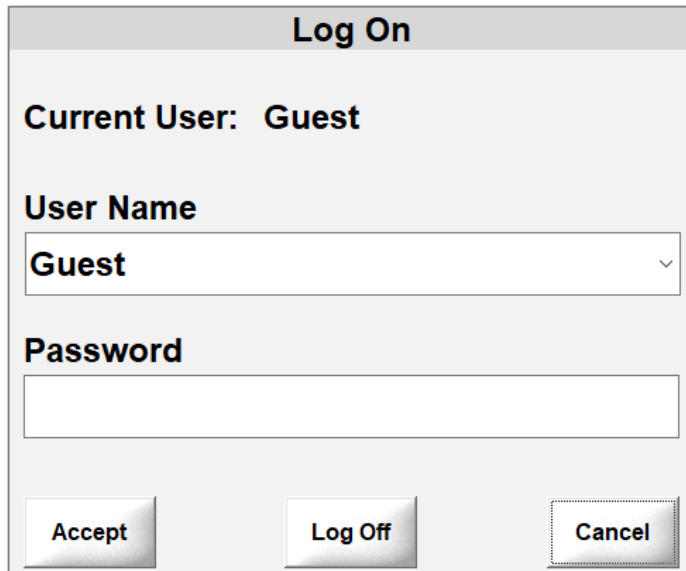
A dialog box titled "Log On" with a grey header. Below the header, it says "Current User: Guest". There is a "User Name" label above a drop-down menu showing "Guest". Below that is a "Password" label above an empty text input field. At the bottom, there are three buttons: "Accept", "Log Off", and "Cancel".

2. Choose a user name from the User Name drop-down menu.

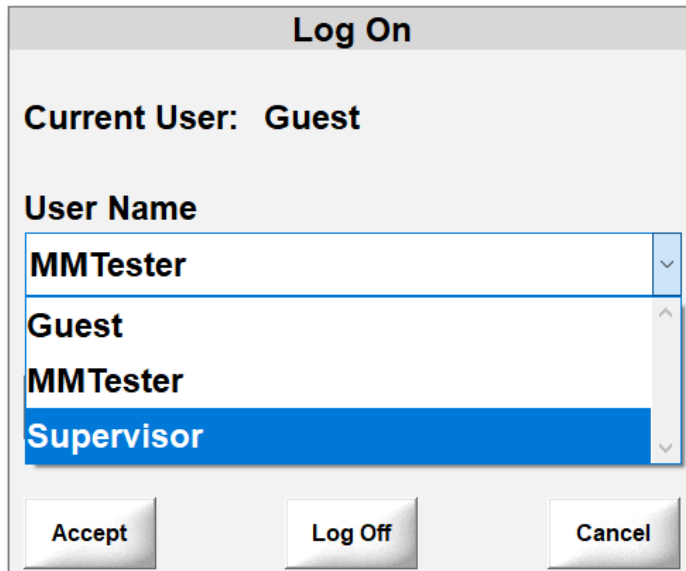
A dialog box titled "Log On" with a grey header. Below the header, it says "Current User: Guest". The "User Name" drop-down menu is open, showing a list of options: "MMTester", "Guest", "MMTester", and "Supervisor". The "Supervisor" option is highlighted in blue. Below the menu is an empty text input field. At the bottom, there are three buttons: "Accept", "Log Off", and "Cancel".

3. Enter the password and choose the checkmark.



4. Choose **Accept** to complete the log-in process.
Once you are logged in, your use rname is displayed under the Login icon in the top menu.

8.4 Creating a New Project

1. Choose **New**.



The project settings dialog box opens.

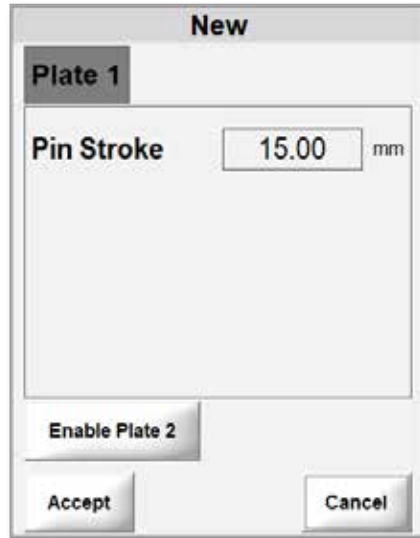

2. Enter the maximum pin stroke.



NOTE

The maximum pin stroke is related to the type of gate used. Please refer to your General Assembly Drawings to find the correct length of the gate for your system



- Optional: If plate 2 needs to be enabled, choose **Enable Plate 2**.

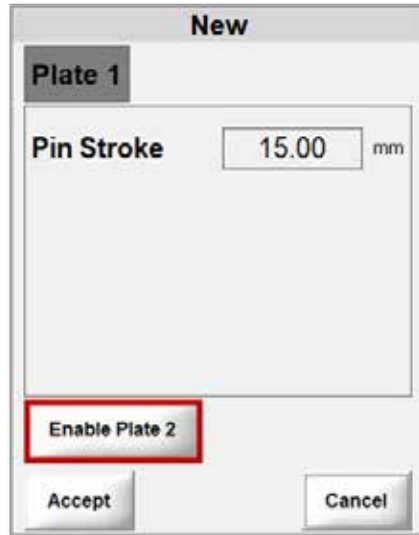

If plate 2 is not detected, the following message is displayed.



If plate 2 uses a different software version, the following message is displayed.



Otherwise, a dialog box with a Plate 2 tab and a Disable Plate 2 button is displayed.



- Choose **Accept**.

8.5 Setting the System Limits

Only users with Supervisor access and higher can configure system limits. These manual settings can be configured:

- jog velocity
- jog ramp
- jog torque/force

The auto settings are maximums based on the limitations of the motor and are configured at the factory:

- velocity max
- ramp max
- torque max

1. Choose **Settings** from the top menu bar to open the Settings box.

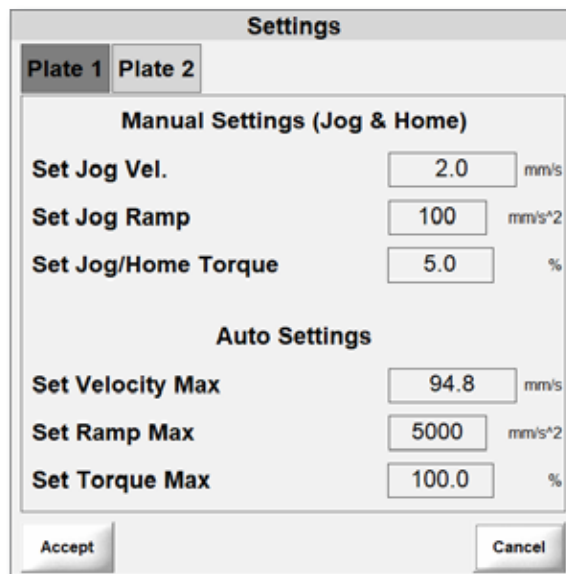

2. When plate 2 is enabled, select **Plate 2** tab to view the settings of plate 2.

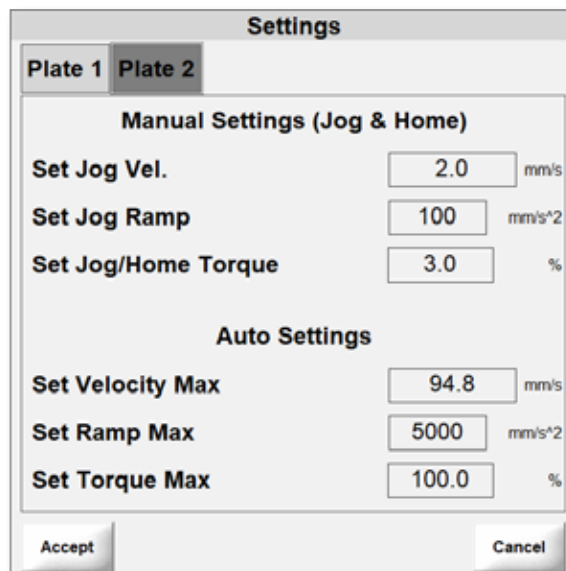

8.5.1 Setting the Jog Velocity

1. Choose Set Jog Vel.

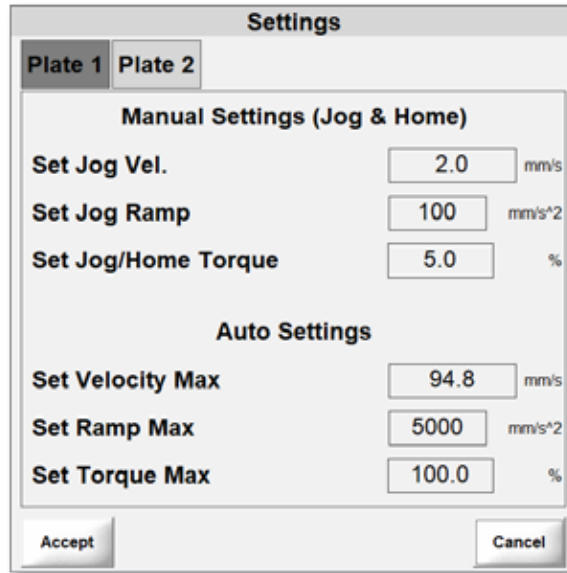

NOTE

The maximum setting for the jog velocity is 5.

2. Enter a value.



3. Choose the checkmark to save the setting.
4. Optional: If plate 2 is enabled, select the Plate 2 tab to enter the settings of plate 2

8.5.2 Setting the Jog Ramp

1. Choose **Set Jog Ramp**.

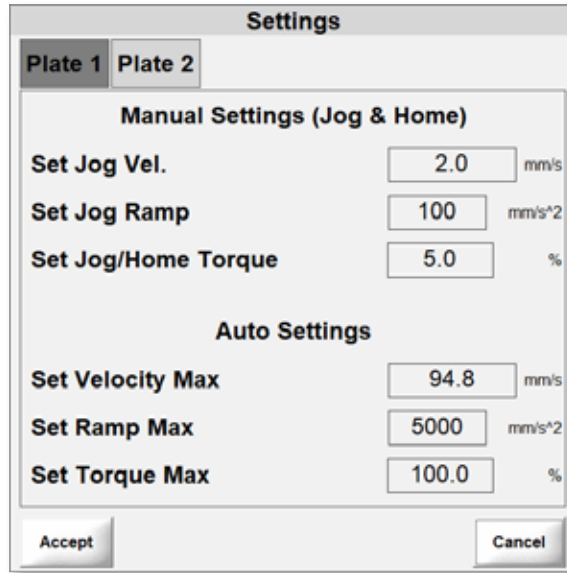

NOTE

The maximum setting for the Jog Ramp is 1000.

2. Enter a value.
3. Choose the checkmark to save the setting.



4. Optional: If plate 2 is enabled, select the Plate 2 tab to enter the settings of plate 2

8.5.3 Setting the Jog/Home Torque

1. Choose **Set Jog/Home Torque**..

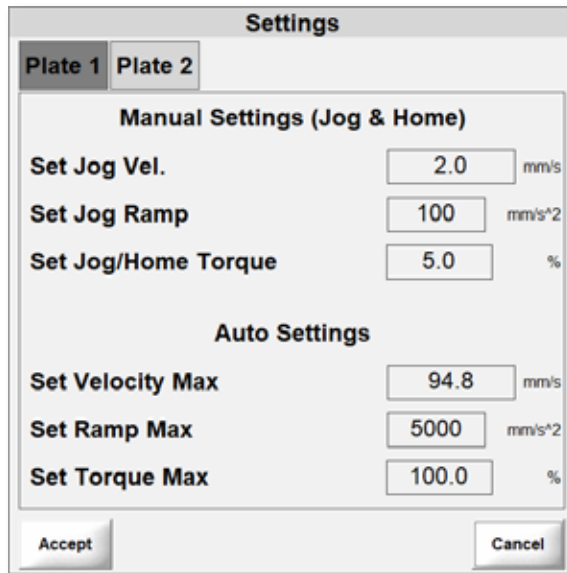

NOTE

The maximum setting for the Jog/Home Torque is 10%.

2. Enter a value.



3. Choose the checkmark to save the setting.
4. Optional: If plate 2 is enabled, select the Plate 2 tab to enter the settings of plate 2.

5. Choose **Accept** to save all the settings.

Messages are displayed in the bottom bar of the Main screen because the servo motors have not been enabled.



8.6 Enabling the Servo Motors

1. Choose a plate and choose the **Servo** button.

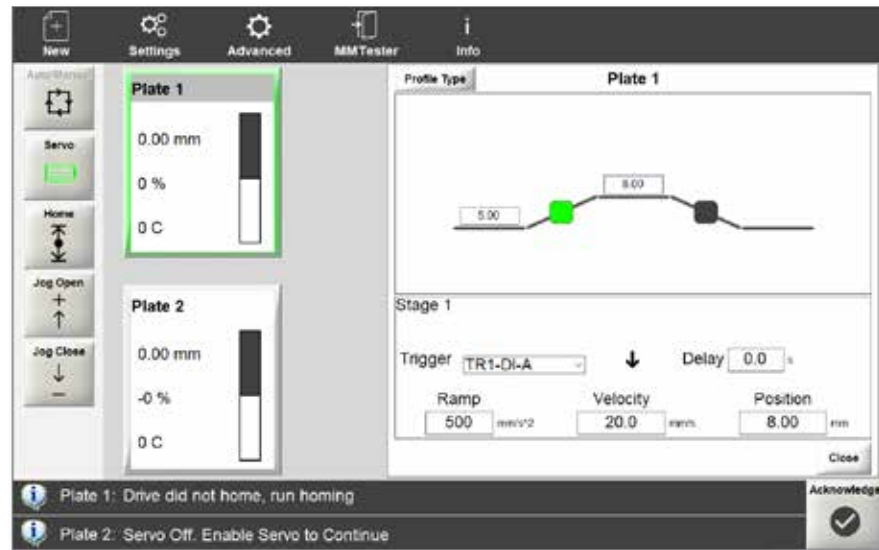

Note:

- The Auto/Manual button is not available.
- The Servo button is now highlighted and enabled.
- The Jog and Home buttons are displayed and available.
- The motion of the valve pin can be tested with the Jog buttons before the Homing process.
- The position value indicator in the gate box changes when the Jog buttons are used.

8.7 Homing the System

For the system to identify open and closed positions for the valve pins, you must home the system.

1. Choose a plate.
2. Choose the Home button.

When the Homing is complete, the following messages are displayed sequentially.



Figure 8-1 Moving towards closed position hard stop



Figure 8-2 Plate1: Set home position

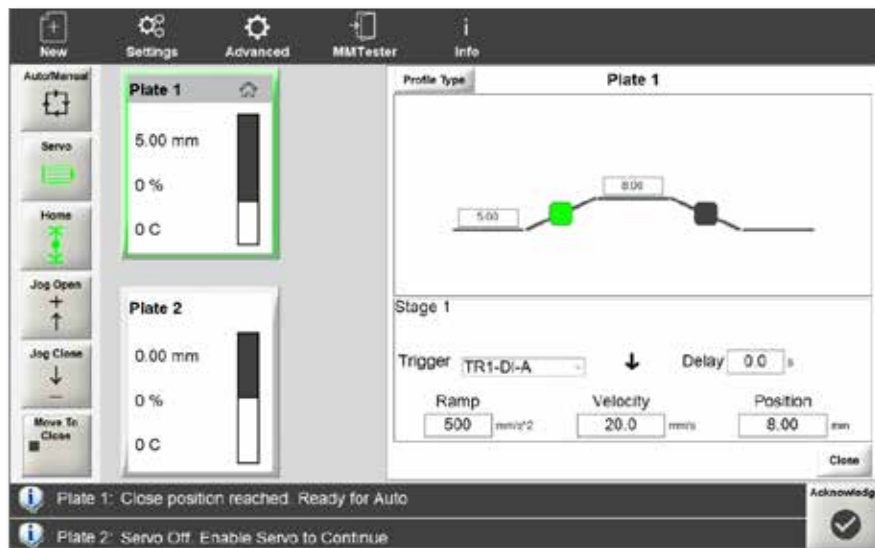

Figure 8-3 Plate 1: Moving towards open position hard stop



Figure 8-4 Plate 1: Moving to close position

After the homing is completed, the Main screen updates to:



Note:

- The Auto/Manual button is available.
- The Servo button is highlighted and enabled.
- The Jog and Home buttons are displayed and can be enabled once a plate is selected.

- The Move To Close button is displayed.
- The home icon is displayed in the top-right corner of the plate:

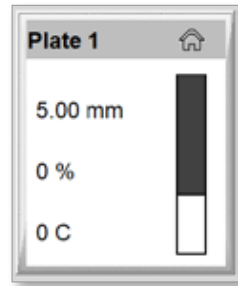

8.7.1 Setting a Profile

You can configure profiles that apply to any of the individual plates.

1. Choose a plate.

A highlighted border appears on the edge of the window of the selected plate:

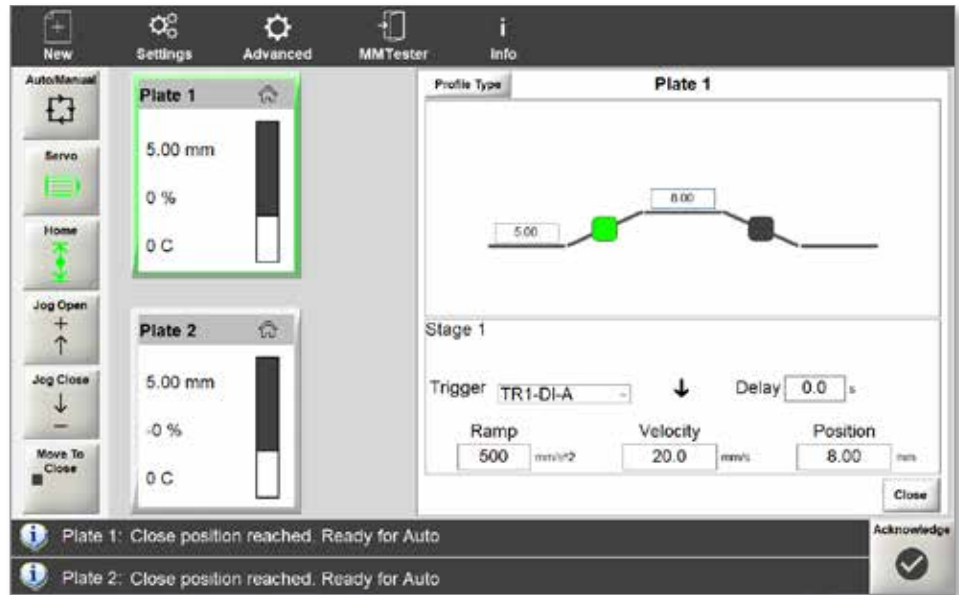

A profile window opens for the selected plate:

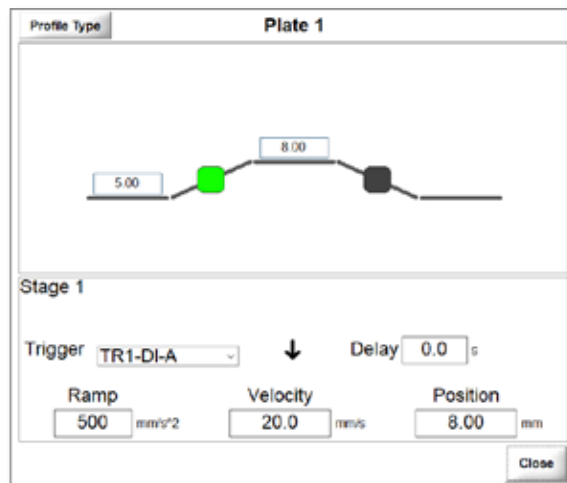

2. Choose the Profile Type button to select the number of stages.

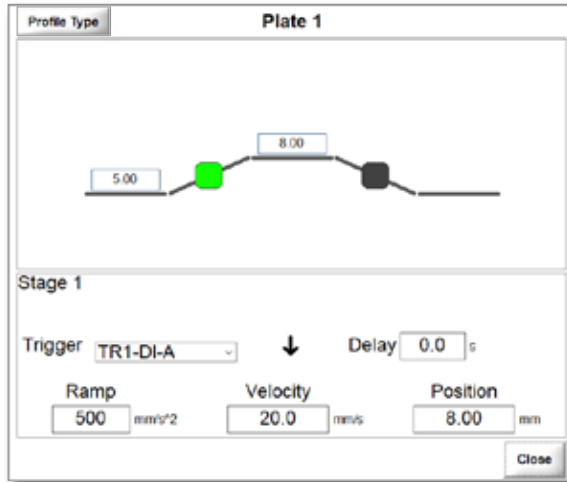

A Profile Type window opens.

3. Choose two, three, or four stages.

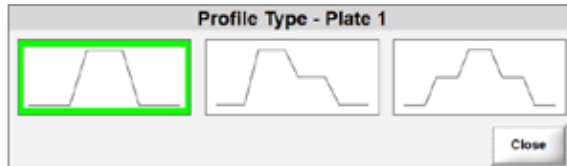

4. Choose the Close button to go back to the Profile window.

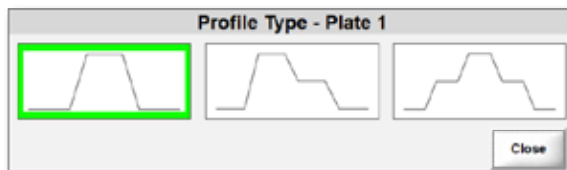

5. Choose the highlighted indicator to select the stage.

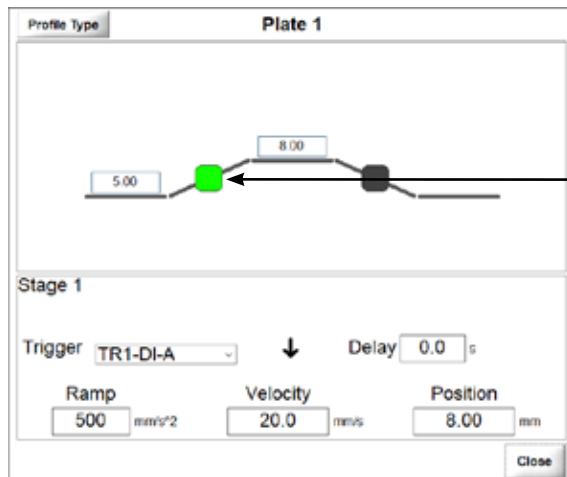

- Choose a digital or an analog (screw position) trigger.

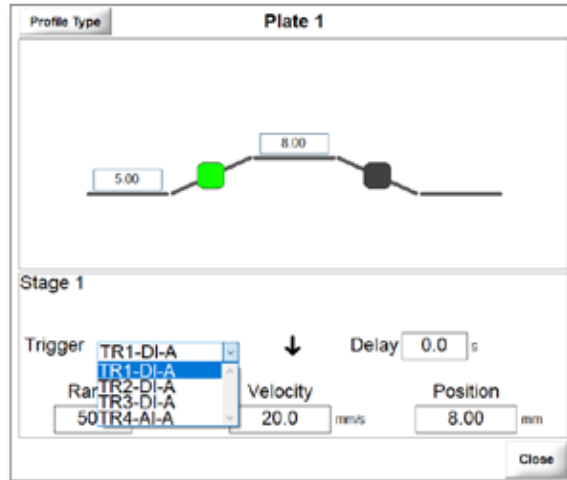

- Choose the timing of the trigger.

- ↑ Rising edge: Triggers when the rising edge of the digital or analog input occurs.
- ↓ Falling edge: Triggers when the falling edge of the digital or analog input occurs.



NOTE
The Time Only option is also available for stages other than stage 1..

- Optional: Set a time delay in seconds.



- Choose the checkmark to save the value.
- Choose **Ramp** and enter a value.



11. Choose the checkmark to save the value.

12. Choose **Velocity** and enter a value.



13. Choose the checkmark to save the value.

14. Choose **Position** and enter a value.



15. Choose the checkmark to save the value.

16. Choose the Close button.

8.8 Viewing Drive Information

The Drive Info screen shows the drive status, a drive message, and whether the drive is referenced. This screen only shows information and has no functionality. To make changes to the drive hardware connections, turn off the controller, make the changes, and reboot the controller to see the changes.

To display the Drive Info screen, do the following steps.

1. Choose **Advanced**.

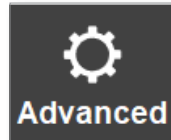

2. Choose **Drive Info**.

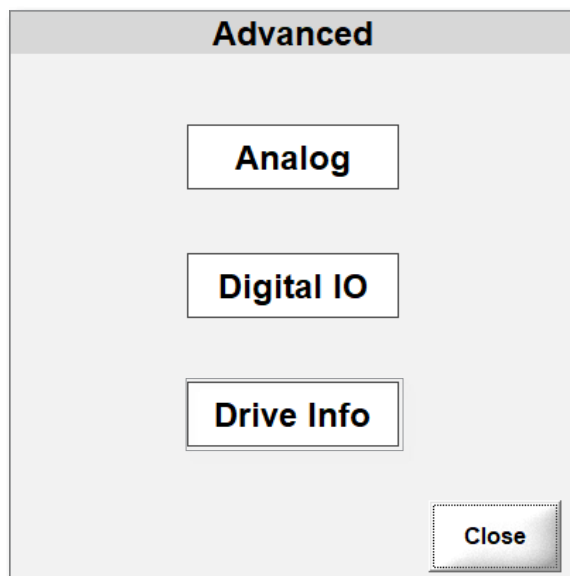

The Drive Info dialog box is displayed.

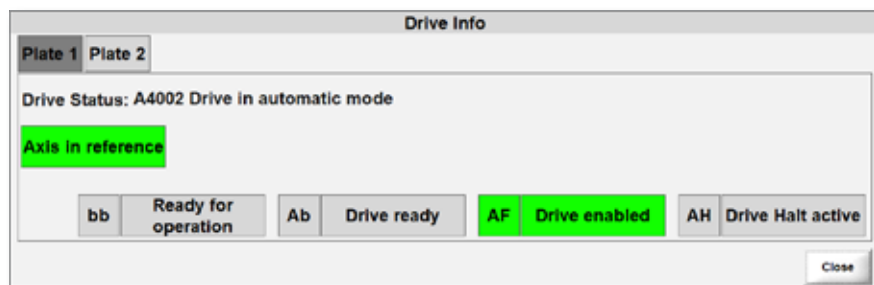

The highlights indicate active states.

8.9 Triggers

You can choose from up to three digital triggers or one analog trigger.

- Digital: The gates are controlled by inputs from the injection molding machine, using rising and falling edges or pulse triggers.
- Analog: An external transducer mounted on the injection molding machine detects the screw position and plate motions are linked to the screw position.



CAUTION

The voltage for the digital input must be DC and a maximum of 24 V. If you use an AC voltage or a voltage higher than 24 V, the servo drive will be damaged and the controller cannot be used. Repair and replacement parts will be required.

Examples of Triggers

The following shows a profile that uses a rising edge for its open trigger and a falling edge for its close trigger.

Stage 1

Trigger TR1-DI-A ↑ Delay 0.0 s

Ramp 500 mm/s² Velocity 20.0 mm/s Position 8.00 mm

Close

Stage 2

Trigger TR3-DI-A ↓ Delay 0.0 s

Ramp 500 mm/s² Velocity 20.0 mm/s Position 5.00 mm

Close

To use a pulse trigger, choose a matching set of a rising trigger and a falling trigger.

Stage 1

Trigger TR1-DI-A ↑ Delay 0.0 s

Ramp 500 mm/s² Velocity 20.0 mm/s Position 8.00 mm

Close

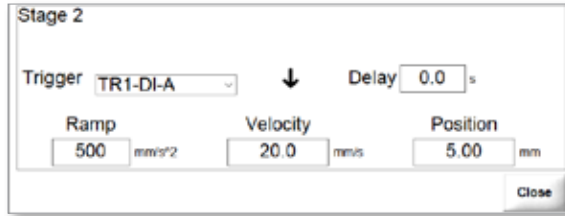

NOTE

Pulse triggers cannot be used with analog inputs.

8.9.1 Setting a Digital Trigger

1. Choose a trigger from the Trigger drop-down menu.

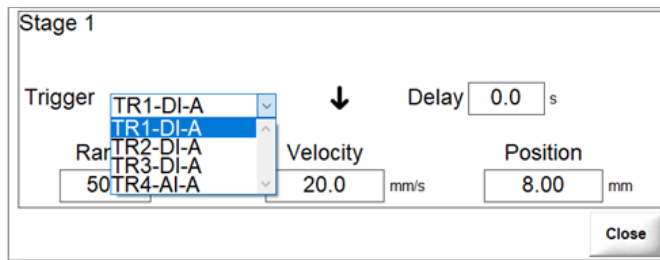

The timing of an open or close trigger can be set to Rising edge or Falling edge.

↑ Rising edge: Triggers when the rising edge of the digital or analog input occurs.

↓ Falling edge: Triggers when the falling edge of the digital or analog input occurs.

2. Choose the timing of the trigger.



NOTE

The Time Only option is also available for stages other than stage 1..

8.9.2 Monitoring Digital Triggers

Digital triggers can be monitored from the Advanced screen.

1. Choose the Advanced button to access the Advanced screen.

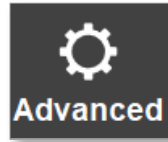

The Advanced options dialog box is displayed.

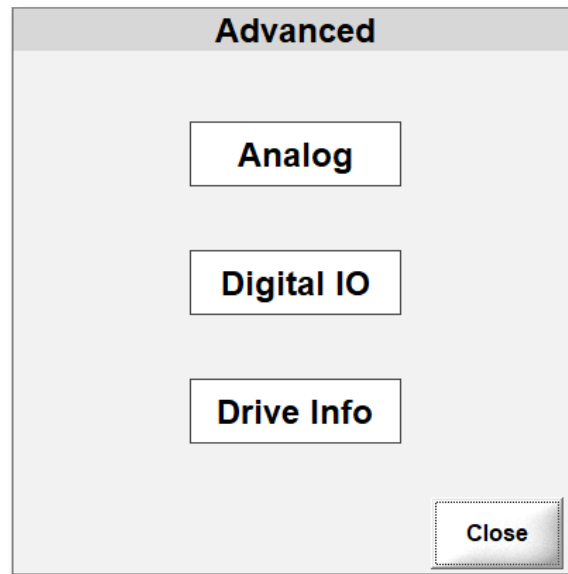

Table 8-1 Advanced Options Buttons	
Button	Description
Analog	Allows you to set up and calibrate analog input
Digital IO	Allows you to monitor digital inputs and outputs
Drive Info	Allows you to view the drive information

Digital inputs and outputs can be on or off.

The boxes next to the inputs and outputs show their status:

- Highlighted: The input or output is active.
- Not highlighted (grayed): The input or output is not active.

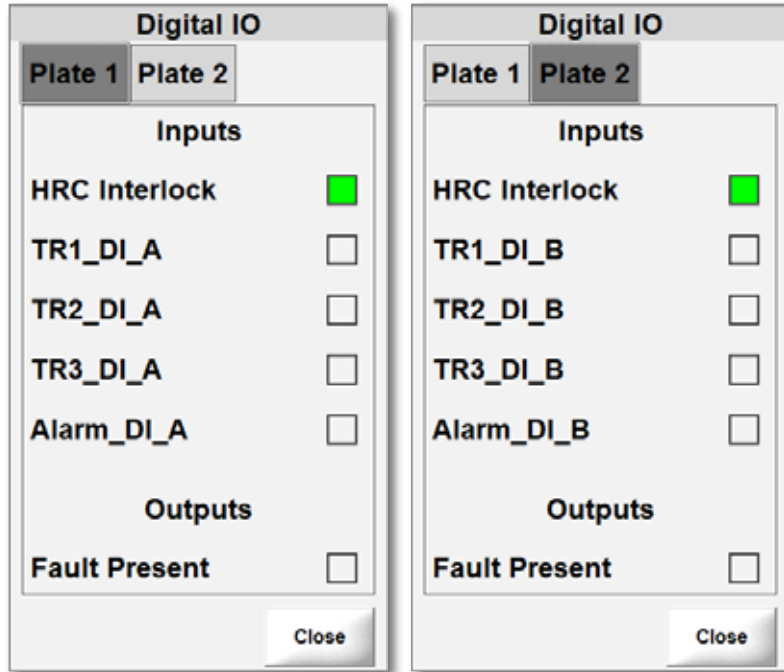
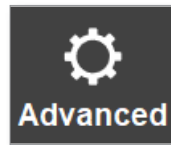

Table 8-2 Digital Inputs and Outputs	
Input	Description
HRC Interlock	Status of external hot runner controller
TR1_DI_A	Digital input 1
TR1_DI_B	A for plate1; B for plate 2
TR2_DI_A	Digital input 2
TR2_DI_B	A for plate1; B for plate 2
TR3_DI_A	Digital input 3
TR3_DI_B	A for plate1; B for plate 2
Alarm_DI_A	Alarm input
Alarm_DI_B	A for plate1; B for plate 2
Output	Description
Fault Present	Indicates a reported error with the E-Drive controller

8.9.3 Calibrating Analog Inputs

The E-Drive can use one analog input per plate. To use analog triggers, you must first calibrate the analog inputs.

1. Choose **Advanced** to open the Advanced screen.



2. Choose Analog from the Advanced dialog box.

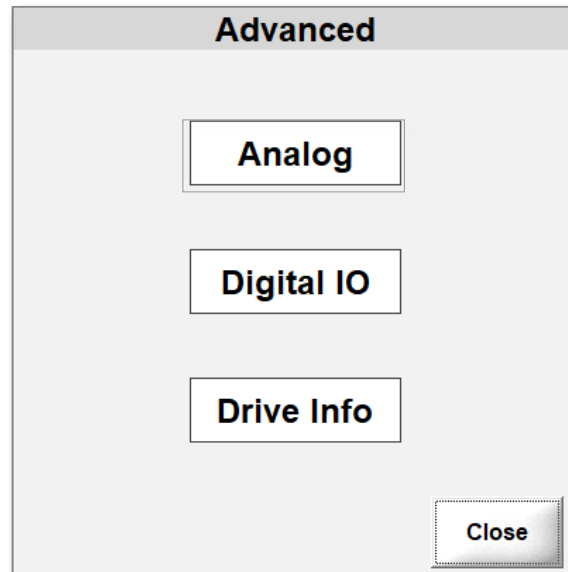

The Analog Scaling dialog box opens.

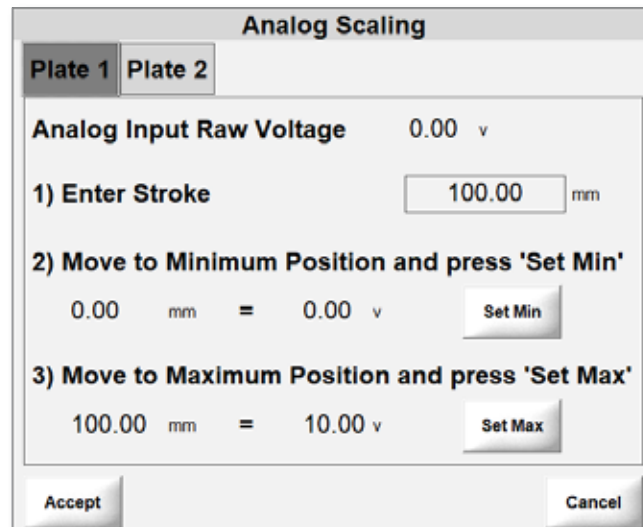

3. Choose a plate tab.

4. Enter a value for the stroke (in this case the length of the transducer).



5. Move the screw fully back.
6. Choose the Set Min to set the minimum position.

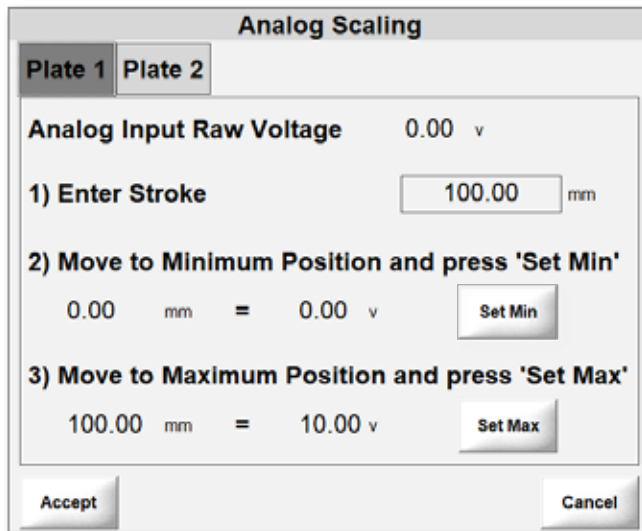

7. Move the screw fully forward.
8. Choose Set Max to set the maximum position.
9. Choose Accept to save the values.

8.9.4 Setting Analog Triggers

1. Choose a trigger from the Trigger drop-down menu.

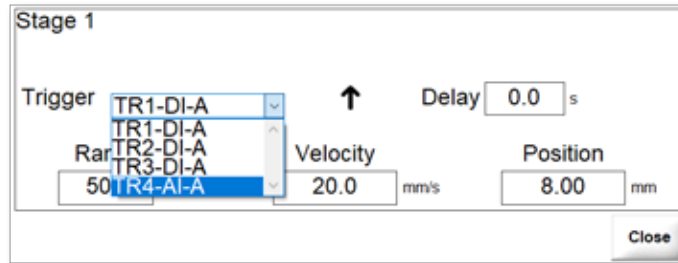

NOTE

The threshold is the position at which the motion step is activated. The maximum value for a threshold is the stroke entered during analog calibration. See “8.9.3 Calibrating Analog Inputs” on page 8-23 for more information.

2. Set a threshold value.

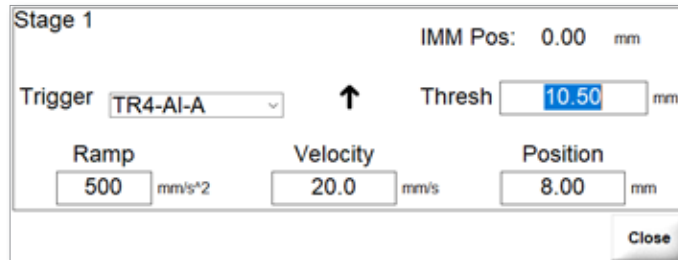

The timing of an open or close trigger can be set to Rising edge or Falling edge.

↑ Rising edge: Triggers when the rising edge of the digital or analog input occurs.

↓ Falling edge: Triggers when the falling edge of the digital or analog input occurs.



NOTE

The Time Only option is also available for stages other than stage 1.

Section 9 - Troubleshooting



WARNING

Ensure that you have fully read “Section 3 - Safety” on page 3-1 before troubleshooting any problems.

9.1 Alarm Messages

Alarm messages warn the user about adverse conditions with the controller or the injection molding machine. These messages are displayed in the bottom information bar:



Note:

- The message displays in flashing red text.
- The Acknowledge button turns red.

Alarm messages are displayed in the bottom information bar until you acknowledge them by pressing **Acknowledge**.



IMPORTANT

Some alarm messages remain visible in the information bar even after acknowledgement. In these cases, you must resolve the condition that has triggered the error message for it to disappear.

Table 9-1 Alarm Messages			
Category	Fault Text	Cause	Notes
Information	Auto mode	Controller is in automatic mode.	
Information	Close position reached. Ready for auto	Plate is at its profile close position and ready to be operated in automatic mode.	
Information	Drive did not home, run homing	Plate is enabled but not homed.	
Information	Jogging	Plate is being jogged.	
Information	Manual mode	Plate is in manual mode.	
Information	Servo off. Enable Servo to continue	Plate is not enabled.	
Alarm	Plate not closed. Close plate to switch to Auto	Plate is not at its closed position as per profile setting AND user attempts to go to Auto mode.	Move to close then try to enter Auto.
Alarm	HRC interlock dropped in Auto	Digital input HRC interlock dropped to false while controller was in auto mode.	Acknowledge the alarm to clear.
Alarm	Temperature interlock open, check hot runner controller	Digital input HRC interlock is false.	HRC interlock input needs to remain true at all times for any motion or servo enable.
Alarm	Homing did not finish in the allowable time	Homing did not complete and timeout has expired.	
Alarm	Homing limits error	Setting and resetting of homing limits failed.	
Alarm	Calculated stroke is not equal to pin stroke	There is blockage in the system or pin stroke is not correct.	
Alarm	Homing error	Homing is interrupted or failed.	
Alarm	Stop button pressed	Stop push-button has been pressed.	
Alarm	Problem with power supply	Drive xx is not receiving proper mains voltage.	Inspect main voltage supply to drive.
Alarm	Initial drive parameters read/write error	Drive initialization failed due to hardware fault, missing connection, etc	Reboot controller. If error persists, for assistance.
Alarm	Unknown motor connected. May not achieve rated speed	Connected motor is not known to the controller.	Be aware that maximum allowed velocity may not be achievable.

Table 9-1 Alarm Messages			
Category	Fault Text	Cause	Notes
Alarm	Extensive deviation	The difference between actual and set positions is outside of allowed bounds.	Inspect system for blockages. Lower maximum allowable accelerations. Increase maximum torque.
Warning	Negative position limit exceeded		Move the plate to valid range using Jog +
Warning	Positive position limit exceeded		Move the plate to valid range using Jog -
Warning	Target position out of travel range	Profile target is outside the travel range.	Modify the profile
Warning	Drive warning		Investigate warning message code in Drive Info.



IMPORTANT

If in doubt about an error message, please contact a Mold-Masters representative.

Section 10 - Wiring Details



WARNING

Ensure that you have fully read “Section 3 - Safety” before connecting the E-Drive controller.

10.1 Three-Phase Supply Cable and Miniature Circuit Breaker (MCB)



CAUTION

Incorrect connection of the three-phase power supply may result in damage to the controller. Cable colors may vary. Wire according to the cable markings.

Cable Marking	Description
L1	Phase 1
L2	Phase 2
L3	Phase 3
Earth Symbol	Ground



Figure 10-1 Disconnect switch and power supply connection

A three-phase MCB is located inside the cabinet. This is the safety overload trip of the cabinet. A disconnect switch is located at rear of the cabinet for isolating the main power supply. The disconnect switch can be used with a locking device.

10.2 Auxilliary Input

A HAN4A cabinet connector provides a simple I/O function.



Figure 10-2 HAN4A connector

The input (pins 2 and 3) looks for a closing signal from the associated hot runner controller. This indicates that the mold is at temperature, which is required for the E-Drive to be used.

Pin	Connection	Input/Output
1	Not used	Spare
2	24 VDC	DC supply
3	Auxiliary input signal	Input from the hot runner controller
4	Not used	Spare

10.3 Machine Interface (HA16)

This connector is for the digital and analog trigger inputs to the E-Drive(s). The connector provides a 24 VDC (pin 10) signal and 0 VDC (pin 9) for the external digital trigger inputs and analog transducer. Digital inputs are assigned to pins 1,2,3, and an analog input is assigned to pin 4 for E-Drive 1 (pins 5,6,7 and pin 8 are for E-Drive 2).



Figure 10-3 HA16 connector

Pin No.	Signal	E-Drive
1	Digital Trigger 1	1
2	Digital Trigger 2	
3	Digital Trigger 3	
4	Analog Trigger 1	
5	Digital Trigger 1	2
6	Digital Trigger 2	
7	Digital Trigger 3	
8	Analog Trigger 1	
9	Not assigned	
10		
12		
13		
14		
15		
16		

10.4 HMI Connection

The connection for the mobile operator panel (HMI) is located on the rear side of the cabinet. The module provides a 24V DC power supply and an Ethernet connection to the HMI, and E-Stop connections and safe-torque-off connections to the E-Drive(s).



CAUTION
 Be careful not to damage the pins on the HMI connector when attaching/detaching the mobile operator panel (HMI) to/from the E-Drive controller.



Figure 10-4 HMI connection

10.5 Servo Connections

There are motor power and encoder connector set(s) on the rear side of the cabinet. The E-Drive controller is supplied with detachable extension cables.



Figure 10-5 Servo connections

Index

A

Actuator Speed vs. Supply Voltage 7-2
Advanced dialog box 8-23
Advanced Options Buttons 8-21
Analog Scaling dialog box 8-23
Assembly (Center Section) 4-5

B

Ball screws 4-3
 Maintenance schedule 6-1
Belt 4-13

C

Components 4-3

D

Digital Inputs and Outputs 8-22
Digital IO 8-21
Drive Info 8-21

F

Falling edge 8-16
Fix Idler 4-3-II

H

Hazard areas, injection molding machine 3-2
Home button 8-12

I

Injection molding machine 3-2

J

jog ramp 8-6
jog torque/force 8-6
jog velocity 8-6

L

Log On dialog box 8-2

M

Magnets 5-5
Maintenance Schedule
 Ball Screw 6-1
maximum pin stroke 8-4
Misalignment 4-15
Motor Mount 4-3-II

P

Password Control 8-1
Plate settings 8-1
Profile Type 8-15

R

ramp max 8-6
Rising edge 8-16

S

Safety
 Lockout 3-10
Safety Hazards 3-13
Settings 8-6
stroke 8-24
Supply Voltage vs. Actuator Speed 7-2

T

Temperatures 4-4-II
Tensioning Idler Assembly 4-3-II
threshold value 8-25
torque max 8-6

V

velocity max 8-6



NORTH AMERICA

CANADA (Global HQ)
tel: +1 905 877 0185
e: canada@moldmasters.com

U.S.A.
tel: +1 248 544 5710
e: usa@moldmasters.com

SOUTH AMERICA

BRAZIL (Regional HQ)
tel: +55 19 3518 4040
e: brazil@moldmasters.com

MEXICO
tel: +52 442 713 5661 (sales)
e: mexico@moldmasters.com

EUROPE

GERMANY (Regional HQ)
tel: +49 7221 50990
e: germany@moldmasters.com

UNITED KINGDOM
tel: +44 1432 265768
e: uk@moldmasters.com

AUSTRIA
tel: +43 7582 51877
e: austria@moldmasters.com

SPAIN
tel: +34 93 575 41 29
e: spain@moldmasters.com

POLAND
tel: +48 669 180 888 (sales)
e: poland@moldmasters.com

CZECH REPUBLIC
tel: +420 571 619 017
e: czech@moldmasters.com

FRANCE
tel: +33 (0)1 78 05 40 20
e: france@moldmasters.com

TURKEY
tel: +90 216 577 32 44
e: turkey@moldmasters.com

ITALY
tel: +39 049 501 99 55
e: italy@moldmasters.com

ASIA

CHINA (Regional HQ)
tel: +86 512 86162882
e: china@moldmasters.com

KOREA
tel: +82 31 431 4756
e: korea@moldmasters.com

JAPAN
tel: +81 44 986 2101
e: japan@moldmasters.com

SINGAPORE*
tel: +65 6261 7793
e: singapore@moldmasters.com

INDIA (Regional HQ)
tel: +91 422 423 4888
e: india@moldmasters.com

*Coverage includes Southeast Asia

OCEANIA

AUSTRALIA
tel: +61 407 638 314
e: australia@moldmasters.com

NEW ZEALAND
tel: +61 407 638 314
e: newzealand@moldmasters.com